

Relay Coupler

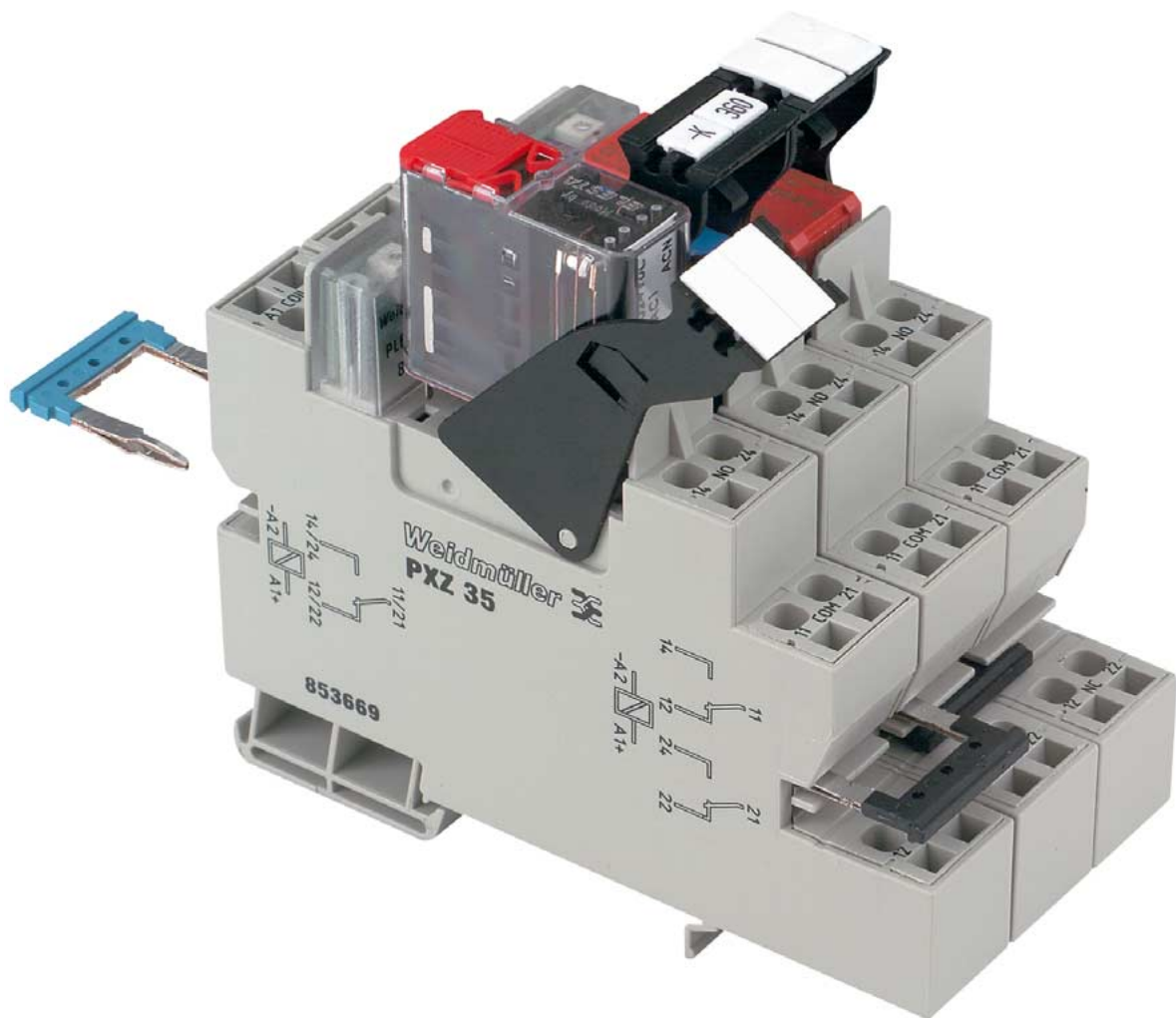

Relay Coupler



The universal foot of the Weidmüller **relay modules** allow them to be assembled on TS 32, TS 35 x 7.5 and TS 35 x 15 mounting rails in accordance with European standards EN 50 035 and EN 50 022.

An LED status indicator in the coil of the relay coupler indicates the relay switching status.

Contact material	Properties	Application	U/I
Fine silver AG 99 %	- inexpensive - average tendency to weld and average resistance to burn-off - subject to corrosion in sulphurous atmosphere	universal use up to medium-size loads	1 V...250 V 1 mA...5 A
Silver nickel ● AgNi 0.15	- high mechanical stability - low tendency to weld - low contact resistance - high resistance to burn-off	universal use at medium-size loads	≥ 12 V 5 mA...10 A
Hard silver AgCu3	- mechanical stability > AgNi - tendency to weld < AgNi - resistance to burn-off > AgNi - contact resistance > AgNi	for use with medium-size loads	≥ 12 V 10 mA...10 A
Silver cadmium oxide ● AgCdO	- very low tendency to weld - resistance to burn-off > AgCu3/Ni	suitable for switching inductive loads	≥ 12 V ≥ 100 mA
Silver-tin-oxide ● AgSnO ₂	- high thermal decomposition temperature - more arc-resistant with low material transfer	suitable for switching inductive loads	≥ 12 V ≥ 100 mA
Tungsten W	- very high resistance to burn-off - high switching rate with short closed times	circuits with extremely high on/off loads	≥ 60 V ≥ 1 A
Hard gold ● AuNi	- < lowest contact resistance - best resistance to corrosion	dry circuits in damp atmospheres	µV...60 V µA...0.2 V

● = preferred materials

Types of contact

The standard range comprises numerous types and combinations of contacts.

- 1 NC (EGR EG2, EGR EG7, RS 30)
- 1 NO (EGR EG2, EGR EG7, DKR, RS 30)
- 1 NC and 1 NO (EGR EG2, WRS)
- 2 NO (WRS)
- 3 NO (WRS)
- 1 Changeover (EGR EG2, EGR/RST EG7, WRS DKR PRS/PRZ MCZ R, RS 30, RS 31)
- 2 Changeover (EGR EG2, WRS, RS 32, PRS/PRZ)
- 4/8/16 Changeover (RSM)

Contact material

The all-round capability of Weidmüller relay modules is achieved by the choice of the contact material.

The contact is responsible for both the reliable transmission of the control signals and for switching power contactors. Weidmüller uses gold-plated or gold-flashed AgNi contacts for most applications. Gold-plated contacts permit the switching of the low-power applications up to 40 µW with a gold-plating thicker than 2 µm. For switching higher ratings we use AgSnO₂ or AgCdO contacts (RS 31).

Relay Coupler



Protective circuits of the contacts

Switching sparks may occur when switching inductive or capacitive loads that affect the operational life of the relay.

The following protective circuits offer the possibility of reducing contact wear:

Diode:

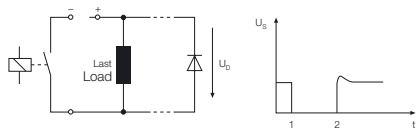

Advantage: can be used for all ratings, low overvoltage, minimum space requirements, economic

Disadvantage: very long drop-out delay

Diode and Z-diode:

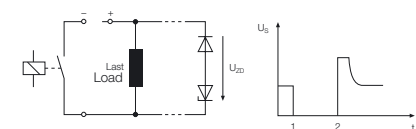

Advantage: low overvoltage (determined by Z-diode), low drop-out delay

Disadvantage: not usable for high power ratings

RC combination:

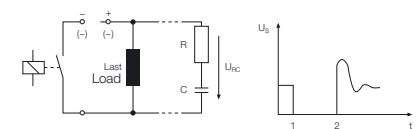

Advantage: low overvoltage, low drop-out delay

Disadvantage: higher current loading on contacts at switch-on, complex and expensive for increased power rating

Varistor:

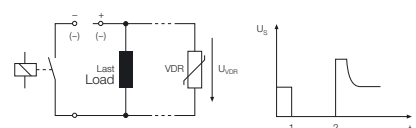

Advantage: low drop-out delay, economic

Disadvantage: not for all operating voltages and power ratings

U_S Voltage curve
1 Close
2 Open

Switching of small and large power ratings

For automation technology, Weidmüller offers the EGR EGR 7 relay coupler to switch ratings up to 40 μW under resistive loads. This allows signals to be reliably relayed to control devices.

The switching of higher power ratings in power supply technology is achieved by the RS 31 relay coupler, which guarantees switching capacity up to 3.5 kVA under resistive loads.

Switching times of the relay modules

pick-up delay typ. < 10 ms
drop-out delay typ. < 12 ms

Switching behaviour/load limit curve (depending on type)

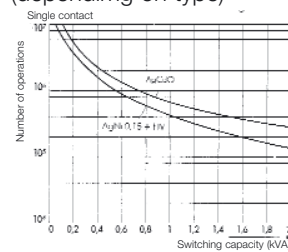

Contact life with resistive load

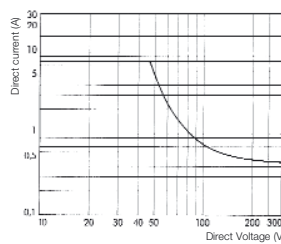

DC-limit with resistive load

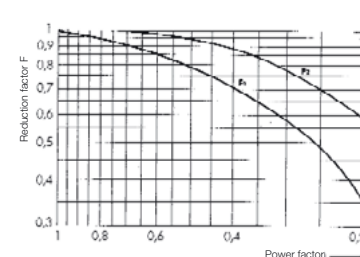

Reduction factor with inductive load $\cos j < 1$
Switching no. eff. = switching no. (at $\cos j = 1$) x red. Factor F

Relay couplers with plugged relays

Relay couplers with plugged relays are only conditionally suitable for use in applications subject to heavy vibrations. Relay couplers with soldered relays are to be preferred.

Derating curves

The contact resistance is largely responsible for heat development within the relay. This link is demonstrated by a derating curve as a function of the permissible current subject to the ambient temperature.

We determine the current (curve a) for the following operating conditions:

- continuous operation
- rated input voltage + 10 %
- several relay modules operating under load, mounted horizontally in a row without spacing on mounting rail

A higher load is applicable when modules are mounted with a gap of 20 mm as shown in curve "b". In addition, the function of curve "b" shows the max. values for a switching or short-time operation when assembled horizontally on the mounting rail.

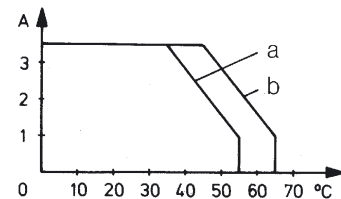

Notes for usage

The characteristic data of the actuation are to be meticulously observed when using UC variants in DC circuitry. UC variants have a higher current input at the moment of switching due to their series circuitry. The internal current limiter of commercially available initiators can result in the operated relay coupler not being switched through.

RC combination

Long supply cables are particularly open to electrical and electro-mechanical influences. These can lead to disturbances of the function or even failure of the relay module. A remedy for this problem is an RC combination in series that filters out unwanted disturbances. RC combinations are available for all customary relay couplers: pluggable (PLUGSERIES) or as terminal block (WDU 12C and DKU 12C).

Protective separation

All equipment required to guarantee "protective separation" must be constructed in such a way that, for example, a mechanical defect cannot reduce the level of insulation. In the case of a relay, this means that if a mechanical defect occurs (bent solder pin, break in winding conductor or broken spring), "protective separation" must be guaranteed.

Relays are specified and tested according to IEC 255 and VDE 0435. Neither standard contains any reference to EN 50 178 (Equipping power installations with electronic equipment) nor is "protective separation" defined. To compound matters the test voltages quoted for the relays are based on different measurement conditions. The test voltages cannot be applied to EN 50 178 or DIN VDE 0106 Part 101. As more and more users employ only equipment that guarantees "protective separation", a lot of manufacturers of relays refer to DIN VDE 0106 and test their products accordingly. Consequently, the quoted values correspond to the requirements for "protective separation".

Standards

The following standards are fulfilled:
EN 50 178

Equipping power installations with electronic equipment
DIN VDE 0106 Part 101

Protection against flow of dangerous currents through the human body; basic requirements for protective separation within electrical equipment.
DIN VDE 0109

Insulation co-ordination within low-voltage system including clearance and creepage distances for assembled PCBs.
DIN VDE 0435

Electrical relays, all-or-nothing relays

Input circuit

Input voltage [V]	Reference voltage at which the relay coupler operates. Typical reference voltages: => 5 V DC, 12, 24, 48, 60, 115, 230 V AC/DC
Input current [mA]	Quotient resulting from input voltage and input resistance. Input resistance => coil resistance + resistance of drive (R, LED, rect. ...)
Rated power consumption [W/VA]	Input voltage x input current AC/DC with tolerance of +/- 10% or +/-15% Typical range for relay coupler: 250 mW > Pv > 1 W 0.4 VA > Pv > 1.2 VA
Pull-in voltage [V]	Smallest input voltage that relay coupler requires in order to respond (T _{amb} = 293 K)
Pick-up current [mA]	Smallest input current required to switch relay from inoperative to operating position (T _{amb} = 293 K)
Pull-in power [W/VA]	Product of pull-in voltage and pick-up current
Drop-out voltage [V]	Voltage level at which relay has definitely released
Self reset current [mA]	Input current level at which relay has definitely released

Output circuit

Output voltage [V]	Max. voltage that can be applied to relay contact
Switching current [A]	Current that can flow for max. of 4 sec. after relay contact has closed
Continuous current [A]	Current that flows continuously after contact has closed
Switching power [W/VA]	Product of output voltage and switching current with resistive, inductive and capacitive load
Min. switching power [mW]	Smallest amount of power that can be switched via contact
Service life	Number of switching operations before contact fails - mechanical => with no electric load - electrical => with resistive or inductive AC/DC load
Pick-up lag [ms]	Length of time from application of energizing voltage until contact closes/opens
Drop-out lag [ms]	Length of time from breaking the energizing circuit until contact closes/opens
Contact bounce time [ms]	Length of time between first and last closing/opening of contact when relay picks up or drops out
Switching frequency [Hz]	Switching operations per sec. with a duty factor of 1 : 2 (t _{on} = t _{off})
Withstand voltage [kV]	Max. test voltage between input and output circuits which does not cause any discharge
Reliable separation	Feature of relay coupler that conform to VDE 0160 and VDE 0106 Part 101
Electric arc	Current flow between contact surfaces as they open, caused by ionization
Contact wear	Switching inductive loads leads to considerable changes in the composition of the materials used. The results are: => formation of pits or peaks on the surface of contacts => failure due to interlocking of contacts
Spark absorption	Limitation of transient overvoltages by connecting supplementary circuit across inductive loads => RC combinations => Z-diodes/suppressor diodes => varistors
Reduction factor	Factor by which service life is reduced when switching inductive loads

Types of Housings for Relay Coupler

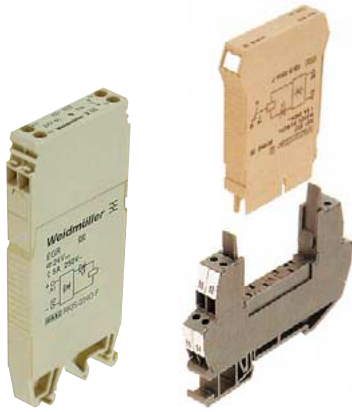

Component housing EG

Weidmüller coupling modules are enclosed in housings appropriate for industrial applications. The housings are suitable for fitting onto mounting rails TS 32, TS 35 x 7.5 or TS 35 x 15 in accordance with European standards EN 50 035 and EN 50 022.

Weidmüller component housings **EG 1** and **EG 2** are 18 mm wide.

The fully enclosed EG housings are equipped with clamping yoke screw connections or push-on connections to connect conductors. Conductors with the following cross-sections can be connected: solid core: 0.5...4 mm² or flexible: 0.5...2.5 mm².

The component housing **EG 7** has a special status. It has been specifically designed to accommodate 10-mm slim relays and optocouplers.

EG 7 relay couplers can be optionally mounted onto TS 32 or TS 35 rails.

The RST EG 7 locking socket is also available for use with the pluggable relays couplers.

The enclosed EG 7 housing are equipped with clamping yoke screw connections. The following conductor cross-sections can be connected:
NO/NC: 0.5...1.5 mm²
Changeover (RST): 0.5...2.5 mm².



Component housing WAVEBOX

It is important to provide modern electronics components with housings suitable for the function. Setting and operating functions must be guaranteed; technical requirements with respect to heat dissipation and EMC properties are to be supported.

An ideal design saves space and wiring costs in the switchgear cabinet. In addition, ergonomics and design are becoming increasingly important for high-quality relay coupler interfaces.

The WAVEBOX fulfils these criteria and is further distinguished by the following:

- Optimal width for any application (12.5 mm, 17.5 mm, **22.5 mm**)
- Large component assembly surface; SMDs mountable on solder side
- No tools required for assembly
- Pluggable PCBs
- Pluggable cross-connection via ZQV 2.5 N
- Hinged, transparent cover
- Screw/plug and socket connector BLZ 5.08
- Optional tension clamp/plug and socket connector BLFZ 5.08
- Marking option with WS tags
- Mount onto TS 35

Connection systems

BLZ screw/plug-in connectors and BLZF tension clamp/plug-in systems for flexible conductors up to 2.5 mm², to guarantee maximum wiring flexibility.

Removing printed circuit boards

Accomplished by depressing the locking clips at the side of the headpiece, and withdrawing the terminal level and PCB from the housing. This is not permitted when the supply is connected.

Cross-connection

The ZQV 2.5 N/2 cross-connector can connect housings of the same family at the base of the housing. The cross-connection can be loaded with a current of up to 8 A. This allows the supply voltage to be cross-connected from one electronics module to another.

The voltage at the cross-connection must not exceed 50 V.

Ventilation vents

Ventilation vents, arranged at an angle, temper and ventilate the lower side of the housings.

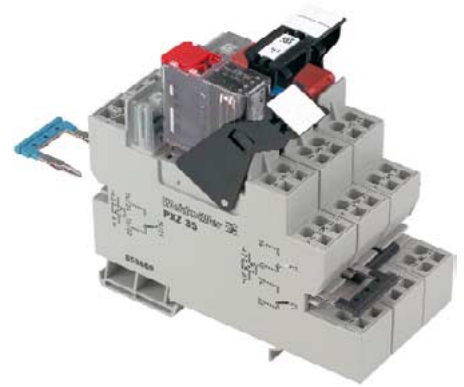

Modular system PLUGSERIES/PLUGRELAY

is a new generation of pluggable relay couplers. The core of this system is an innovative relay socket **PXS** or **PXZ**. Weidmüller has combined the functionality and experience from its relay and terminal block business in this product.

The PLUGRELAY is the ideal connection technology between the relay and the application.

Modular system principle

The PLUGSERIES is particularly service friendly.

Commercially available relays are plugged; retainer and release clips ensure stability, LED indicators with free-wheeling diodes can be easily plugged.

- Relays can be easily plugged
 - suitable for small electric circuits
 - standard design and BGD
- Independent connection technology: screw or tension clamp rated cross-section 0.5...2.5 mm²
- Robust design of retainer / release clip
- One or two changeover contacts Max. current switched 16 A
- Low wiring costs thanks to ZQV 25N cross-connectors (pluggable)
- Service-friendly modular system
 - relay socket, LED indicators, retainer clips and relays
 - mount onto TS 35
 - marking options with WS markers on retainer clips
- Pluggable LED indicator with free-wheeling diode

Types of Housings for Relay Coupler

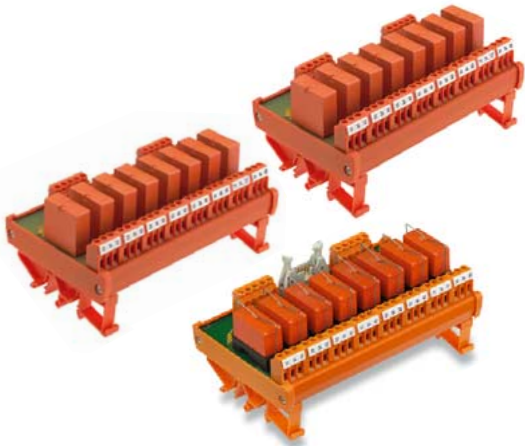

Weidmüller RS locking socket

Locking sockets with relays RS 30, 31, 32 are either 11.2 mm or 25 mm wide depending on version. The open profile makes the use of pluggable relays possible.

Modules mounted onto the locking sockets are provided with clamping yoke screw connections or push-on connectors for wiring conductors.

Conductors with the following cross-sections can be connected:

solid core: 0.5...4 mm²

flexible: 0.5...2.5 mm².

Locking sockets with multiple interfaces

RSM multiple interfaces can be optionally assembled with 4, 8 or 16 relays.

To save wiring costs on the input side, variants are offered with joint positive and negative potentials.

The PCB connectors are provided with clamping yoke screw connections for conductors with the following cross-sections:
solid core: 0.5...4 mm²
flexible: 0.5...2.5 mm².

Some versions of the RSM coupler have a male connector block available for connecting pre-assembled cables on the input side in accordance with IEC 603-1/DIN 41 651.

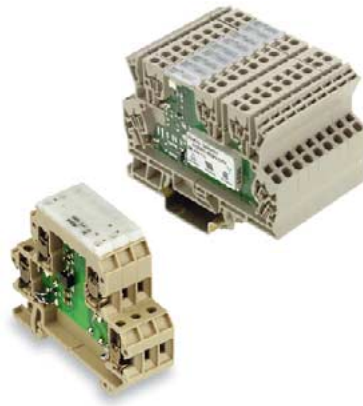

Minicoupler DK

All DKR mini coupler components fulfil demands for slimmest possible design. The sensational width of only 6 mm is achieved by using state-of-the-art surface mountable components SMDs. 4 and 5 screw-connections are offered for 0.5...4 mm² conductor cross-sections. The mini couplers offer a wide spectrum for coupling digital sensor/actuator signals between automation devices and the field process. DKR relay couplers can receive and standardise signals with varying voltages from the field.

Miniconditioner MCZ

The 6-mm MCZ housing is one of the slimmest of its kind. It has the following distinguishing features:

- Z-spring reduces mounting costs
- integrated cross-connection options in the input and outputs minimise wiring costs

MCZR miniconditioner (relay coupler) are available with 4 or 5 Z-spring connections. The clampable conductor cross-section is 0.5...1.5 mm².

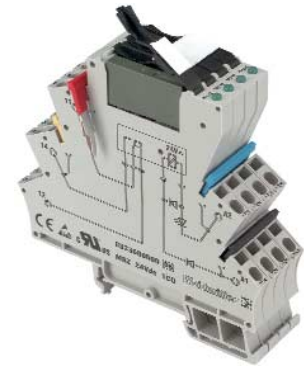

MICROSERIES

The relay coupler and optocoupler variants from the **MICROSERIES** are used in applications in industrial automation to isolate and couple digital input and output signals. Their compact design means that they are particularly suitable for use on sub-distribution boards as well as in switchgear cabinets where they help the user to make optimum use of valuable switching space. With its compact design, the **MICROSERIES** elegantly combines the functionality of the classic coupling level and the terminal level.

- 6.1-mm mounting width
- Pluggable cross-connections of four potentials in the inputs and outputs
- Proven cross-connection system ZQV 4 N
- Wide input voltage spectrum from 5 ... 230 V
- LED-indicator reverse-connect protection free-wheeling diode
- Housing material: WEMID
Flammability class: V0 in accordance with UL 94
- Innovative retaining and release system
- Marking surfaces for fitting standard WS 12/6 markers









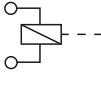

CE-marking

Weidmüller relay couplers are marked with the CE symbol and comply with the requirements of EN 50 081 Part 1 and EN 50 082 Part 2. They can therefore be used for both industrial as well as for applications in residential, commercial and light industry.

Appropriate ESD measures should be taken during installation. If supply cables are particularly long, overvoltage protection should be provided to prevent interference from electrical disturbance in the atmosphere.

Relay Coupler

Electromechanical switching

	Output									
24 V										
Housing										
EG	● 0133660000 Page 72 ● 0536260000 Page 72	● 0133560000 Page 72 ● 0542660000 Page 72						● 0160260000 Page 73 ● 0123060000 Page 73		
WAVESERIES WRS			● 8275350000 ● 8286280000 ● 8416210000 ● 8418220000 ● 8418230000 Page 74	● 8418240000 ● 8418250000 Page 76	● 8418270000 ● 8418280000 Page 77	● 8418330000 Page 79	● 8418300000 ● 8418300000 ● 8418310000 ● 8418320000 Page 78			
EG 7*	● 8216520000 ● 8147120000 ● 8092340000 Page 80	● 8216530000 ● 8147140000 ● 8092350000 Page 80	● 8216570000 ● 8216560000 ● 8216580000 Page 80							
PLUGSERIES PRS / PRZ			● 8530621001 ● 8530691001 ● 8536530000 ● 8536650000 Page 82				● 8530631001 ● 8530701001 ● 8536560000 ● 8536680000 Page 82			
RS 30	● 1101661001 ● 1101611001 ● 1101621001 ● 1101761001 ● 1101711001 ● 1101721001 Page 91	● 1100961001 ● 1100911001 ● 1100921001 ● 1101061001 ● 1101011001 ● 1101021001 Page 91	● 1181511001 ● 1181521001 ● 1100260000 ● 1100210000 ● 1100220000 ● 1100360000 Page 91							
RS 31			● 1128361001 ● 1128331001 ● 1128311001 Page 92							
RS 32							● 9406121001 ● 9406221001 Page 94			
RSM							● 1173461001 ● 1113361001 ● 1113461001 ● 1112361001 ● 1112761001 Page 97	● 1113161001 ● 1100061001 ● 1113561001 ● 1113661001 ● 1107761001 ● 1112661001 ● 1113861001 Page 97	● 1113261001 ● 1100161001 ● 1113761001 ● 8018221001 ● 1107861001 ● 1113861001 ● 1113061001 ● 1173661001 Page 97	
DKR 32	● 8016620000 ● 8008110000 Page 70									
DKR 35	● 8016610000 ● 8008170000 Page 70 ● 8215620000 Page 71		● 8181980000 ● 8181970000 Page 71							
DKR 35/32			● 9454910000 Page 71							
MCZ R			● 8365980000 ● 8442960000 ● 8390590000 Page 68							
MICROSERIES MRS / MRZ			● 8533640000 ● 8533660000 ● 8556050000 ● 8556120000 Page 87							

* Approval by Germanischer Lloyd

Reliable
separation

● 24 V dc
● 24 V_{uc}/ac

Relay Coupler

Electromechanical switching

Output

48 V

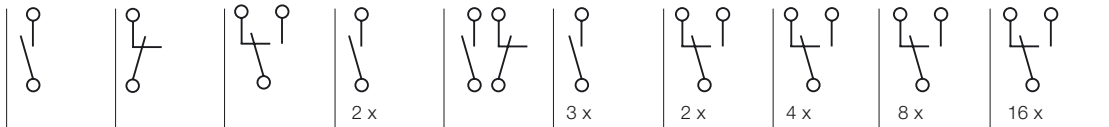
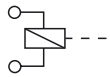

Housing

EG	● 0662660000 Page 72	● 0662460000 Page 72				● 0160360000 ● 0123260000 Page 73				
WAVESERIES WRS			● 8286280000 Page 74	● 8418250000 Page 76	● 8418280000 Page 77	● 8418310000 Page 78				
EG 7*	● 8092370000 Page 81	● 8092380000 Page 81	● 8216590000 Page 81							
RS 30	● 1101861001 ● 1101811001 ● 1101821001 ● 1101961001 ● 1101911001 ● 1101921001 Page 91	● 1101161001 ● 1101111001 ● 1101121001 ● 1101261001 ● 1101211001 ● 1101221001 Page 91	● 1100460000 ● 1100410000 ● 1100420000 ● 1100560000 Page 91							
RS 31			● 1150761001 Page 92							
RS 32						● 9406321001 Page 94 ● 9406421001 ● 1122661001 Page 95				
RSM						● 1114061001 ● 1113961001 ● 1112461001 ● 1173761001 Page 97	● 1114161001 ● 1114261001 Page 97	● 1114361001 ● 1114461001 Page 97		
MICROSERIES MRS / MRZ			● 8556040000 ● 8556110000 Page 87							
EG						● 0141360000 ● 0160460000 Page 73				
WAVESERIES WRS			● 8418220000 Page 75	● 8418260000 Page 76	● 8418290000 Page 77					
EG 7*	● 8092430000 Page 81	● 8092440000 Page 81	● 8216610000 Page 81							
PLUGSERIES PRS / PRZ			● 8536510000 ● 8536610000 ● 8530640000 ● 8530790000 Page 82			● 8536520000 ● 8536630000 ● 8530660000 ● 8530720000 Page 82				
RS 30	● 1155161001 ● 1155111001 ● 1155121001 ● 1102161001 ● 1102111001 ● 1102121001 Page 91	● 1155211001 ● 1155261001 ● 1155221001 ● 1101461001 ● 1101411001 ● 1101421001 Page 91								
RS 31			● 1150361001 ● 1150461001 Page 92							
RS 32						● 1122761001 ● 9406621001 Page 95				
RSM						● 1114561001 Page 97	● 1114661001 Page 97	● 1114761001 Page 97		
MCZ R			● 8420880000 ● 8467470000 Page 61							
MICROSERIES MRS / MRZ			● 8556030000 ● 8556100000 Page 87							

* Approval by Germanischer Lloyd

Reliable separation

- Vdc
- Vuc/ac

Relay Coupler

Electromechanical switching

Output

230 V

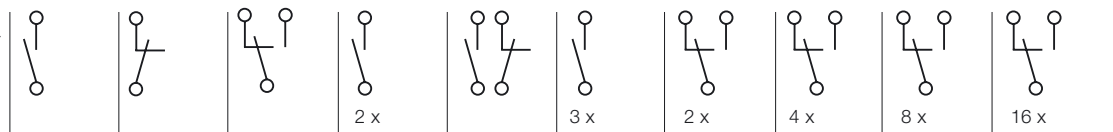

Housing

EG	● 0543860000 Page 72	● 0543660000 Page 72					● 0142460000 Page 73		
WAVESERIES WRS			● 8418230000 Page 75	● 8418260000 Page 76	● 8418290000 Page 77	● 8418340000 Page 79	● 8418320000 Page 78		
EG 7*	● 8092460000 Page 81	● 8092470000 Page 81	● 8216620000 Page 81						
PLUGSERIES PRS / PRZ			● 8530671001 ● 8530731001 Page 82				● 8530681001 ● 8530741001 Page 82		
RS 30	● 1102261001 ● 1102211001 ● 1102221001 Page 91	● 1101561001 ● 1101511001 ● 1101521001 Page 91	● 1100860000 Page 91						
RS 31			● 1128461001 ● 1128431001 ● 1128411001 Page 93						
RS 32							● 9406721001 ● 1122761001 Page 95		
RSM							● 1114861001 ● 1123461001 Page 97	● 1114961001 ● 1108061001 Page 97	● 1115061001 ● 1108261001 Page 97
MCZ R			● 8237710000 Page 69						
MICROSERIES MRS / MRZ			● 8556020000 ● 8556090000 Page 87						
240 V									
RS 30	● 1128561001 ● 1128511001 ● 1128521001 Page 91	● 1128661001 ● 1128611001 ● 1128621001 Page 91							











* Approval by Germanischer Lloyd









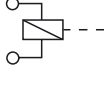

Reliable separation

● 230 Vuc/ac

Relay Coupler

Electromechanical switching

	Output										
											
12 V 				2 x		3 x		2 x	4 x	8 x	16 x
Housing											
EG								● 0160160000 Page 73			
WAVESERIES WRS					● 8418240000 Page 76	● 8418270000 Page 77		● 8418300000 Page 78			
EG 7*	● 8092310000 Page 80	● 8092320000 Page 80	● 8216550000 Page 80								
PLUGSERIES PRS / PRZ					● 8536471001 ● 8536571001 Page 82			● 8536501001 ● 8536591001 Page 82			
RS 30	● 1129421001 Page 91	● 1129521001 Page 91	● 1129660000 Page 91								
RS 32								● 9406021001 Page 94			
DKR 35	● 8171100000 Page 70										
MICROSERIES MRS / MRZ					● 8556070000 ● 8556140000 Page 86						

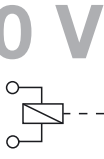
	Output										
											
4...60 V 				2 x		3 x		2 x	4 x	8 x	16 x
Housing											
WAVESERIES WRS 2, 4...24 V					● 8275320000 Page 74						
WAVESERIES WRS 60 V					● 8418210000 Page 74						
EG 7*, 60 V	● 8092400000 Page 81	● 8092410000 Page 81	● 8216600000 Page 81								
RS 30, 60 V	● 1102061001 ● 1102011001 ● 1102021001 Page 91		● 1100660000 ● 1100610000 ● 1100620000 Page 91					● 9406521001 Page 94			
DKR 32, 5 V	● 8019600000 Page 70										
DKR 35, 5 V	● 8019610000 Page 70										
MCZ R, 60 V					● 8470380000 Page 68						
MICROSERIES MRS / MRZ, 5 V					● 8556080000 ● 8556150000 Page 86						
MICROSERIES MRS / MRZ, 60 V					● 8556060000 ● 8556130000 Page 87						

* Approval by Germanischer Lloyd

Reliable separation

● Vdc
● Vuc/ac

Digital signal processing

Relay Couplers in Component Housings

Miniconditioners MCZ R



MCZ R 24 Vdc

MCZ R 24 Vdc/Au

MCZ R 24 Vac/dc

MCZ R 60 Vdc

Limit diagram

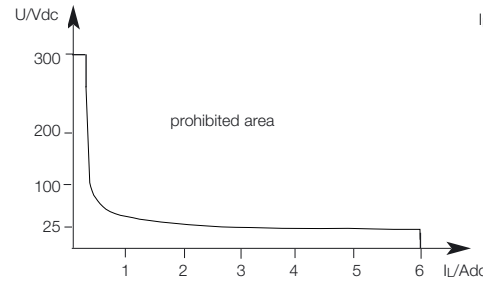

Derating curve

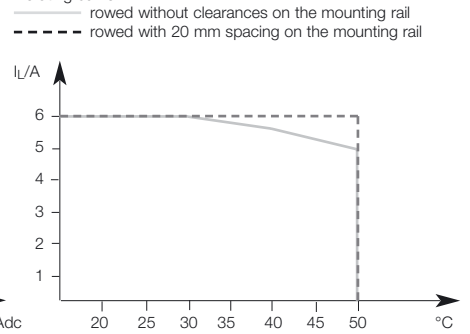

Schematic circuit diagram

This module can be used as a universal interface between the controller and actuator for switching medium-sized loads.

- Reduces installation and commissioning times by use of the proven Z-spring connection technology
- Pluggable cross-connections in input and output minimise wiring costs
- 6-mm width

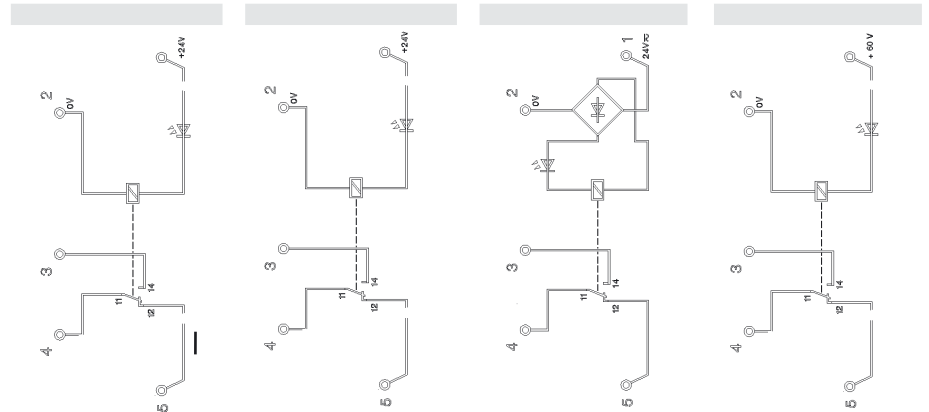

Ordering data	Type	Cat. No.	Type	Cat. No.	Type	Cat. No.	Type	Cat. No.
for TS 35	MCZ R 24 Vdc	8365980000	MCZ R 24 Vdc/Au	8442960000	MCZ R 24 Vac/dc	8390590000	MCZ R 60 Vdc	8470380000
Technical data								
Input								
Input voltage	24 Vdc ±20 % (19.2...28.8 V)		24 Vdc ±20 % (19.2...28.8 V)		24 Vac/dc ±10% (21.6...26.4 V)		60 Vdc ±20% (48...72 V)	
Input current at U _N	6.3 mA ±10 % (5.7...6.9 mA)		6.3 mA ±10 % (5.7...6.9 mA)		ac: 10.8 mA±15% (9.2...12.4 mA) dc: 6.1 mA ±15% (5.2...7.1 mA)		3 mA ±20 % (12.4...3.6 mA)	
Max. input power	156 mW ±10%		156 mW ±10%		ac: 160 mVA ±10 % dc: 151 mW ±10 %		180 mW ±45 %	
Making threshold	12 V...19 V		12 V...19 V		ac: ca. 17 V / dc: ca. 19 V		ca. 38 V	
Cut-out threshold	4 V...5.5 V		4 V...5.5 V		ac: ca. 7 V / dc: ca. 4 V		ca. 14 V	
Reaction time at U _N (typ.)	4.5 ms		4.5 ms		5 ms		4.5 ms	
Release at U _N (typ.)	10 ms		10 ms		30 ms		10 ms	
Capacity working resistance to reduction at dissipated energy	no		no		no		no	
Functionality	operating indication reverse polarity protect. diode free wheel diode		operating indication reverse polarity protect. diode free wheel diode		operating indication bridge rectifier		operating indication reverse polarity protect. diode free wheel diode	
Cross-connection on pin	2, 3, 4		2, 3, 4		2, 3, 4		2, 3, 4	
Output								
Switching voltage	1 changeo. cont. (AgSnO ₂) max. 300 Vdc / 400 Vac		1 changeo. cont. (5 µ Au) max. 300 Vdc / 400 Vac		1 changeo. cont. (AgSnO ₂) max. 300 Vdc / 400 Vac		1 changeo. cont. (AgSnO ₂) max. 300 Vdc / 400 Vac	
ac: continuous current/switching power (see derating diagram)	max. 6 A / max. 1500 VA		max. 6 A* / max. 1500 VA		max. 6 A / max. 1500 VA		max. 6 A / max. 1500 VA	
Min. switching current	100 mA (at U = 10 V)		1) 0.1 mA		100 mA (at U = 10 V)		100 mA (at U = 10 V)	
Switch-on current	max. 6 A		max. 6 A*		max. 6 A		max. 6 A	
dc: Continuous current/switching power	see limit diagram		see limit diagram		see limit diagram		see limit diagram	
Mechanical service life	20 x 10 ⁶ switching operations		20 x 10 ⁶ switching operations		20 x 10 ⁶ switching operations		20 x 10 ⁶ switching operations	
Max. switching frequency at nominal load	0.1 Hz		0.1 Hz		0.1 Hz		0.1 Hz	
Insulation coordination acc. to EN 50178								
Rated voltage	300 V		300 V		300 V		300 V	
Rated impulse voltage	4 kV		4 kV		4 kV		4 kV	
Overvoltage category	III		III		III		III	
Pollution severity	2		2		2		2	
Clearances and creepage distances	≥ 5.5 mm		≥ 5.5 mm		≥ 5.5 mm		≥ 5.5 mm	
Insulation coord.- and voltage proof, input/output mounting rail	4 kV _{eff} / 1 min		4 kV _{eff} / 1 min		4 kV _{eff} / 1 min		4 kV _{eff} / 1 min	
Ambient temperature	-25 °C...+50 °C		-25 °C...+50 °C		-25 °C...+50 °C		-25 °C...+50 °C	
Storage temperature	-40 °C...+60 °C		-40 °C...+60 °C		-40 °C...+60 °C		-40 °C...+60 °C	
Conductor	AWG 22...12		AWG 22...12		AWG 22...12		AWG 22...12	
Conductor cross-section	1.5 mm ²		1.5 mm ²		1.5 mm ²		1.5 mm ²	
Approvals	CE, UL, CSA, GL		CE, UL, CSA, GL		CE, UL, CSA, GL		CE, UL, CSA	
Overall width	6 mm		6 mm		6 mm		6 mm	
Accessories	Type	Cat. No.	Type	Cat. No.	Type	Cat. No.	Type	Cat. No.
End plate	AP MCZ 1.5	8389030000	AP MCZ 1.5	8389030000	AP MCZ 1.5	8389030000	AP MCZ 1.5	8389030000
Further accessories, dimensions and connection data see	Page 305		Page 305		Page 305		Page 305	

¹⁾ depends on load conditions

* the hard-gold plating is resistant for parameters 36 Vdc, 50 mA with 10⁶ cycles

Relay Couplers in Component Housings

MCZ R 110 Vdc

MCZ R 120 Vac

MCZ R 230 Vac

Limit diagram

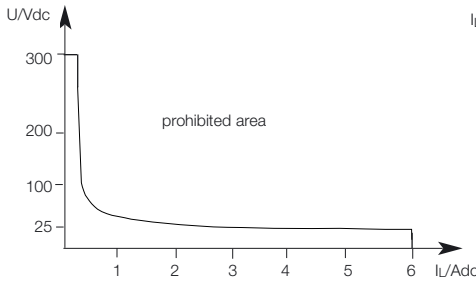

Derating curve

— rowed without clearances on the mounting rail
 - - - rowed with 20 mm spacing

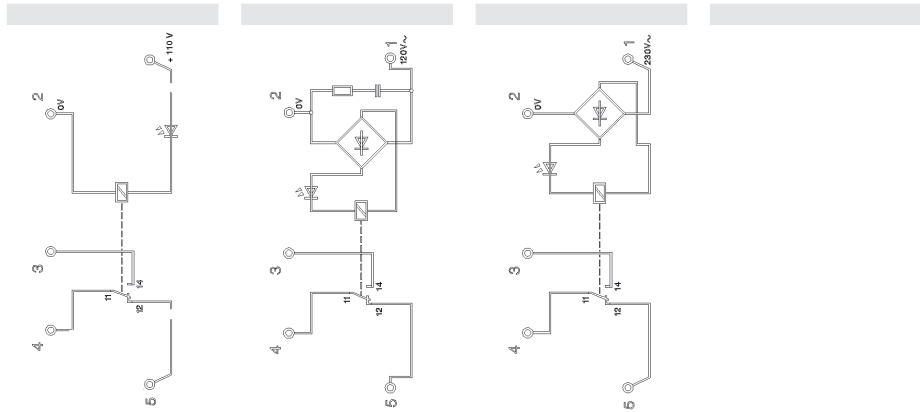
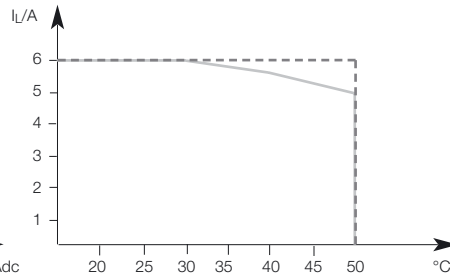

Type	Cat. No.	Type	Cat. No.	Type	Cat. No.
MCZ R 110 Vdc	8467470000	MCZ R 120 Vac	8420880000	MCZ R 230 Vac	8237710000
110 Vdc ±10%		120 Vac -15 %/+10 %		230 Vac ±10%	
2.85 mA ±25%		7 mA ±15 %		9.5 mA ±15 % (8...11mA)	
340 mW ±25%		0.85 VA ±15 % (380 mW ± 15 %)		2.1 VA ±15 %	
ca. 68 V / 1.6 mA		ca. 70 V / 4 mA		ca. 115 V / 5 mA	
ca. 19 V / 0.4 mA		ca. 22 V / 1.3 mA		ca. 60 V / 2.5 mA	
4.5 ms		8 ms		8 ms	
10 ms		30 ms		30 ms	
no		yes		no	
operating indication		operating indication		operating indication	
bridge rectifier		bridge rectifier		bridge rectifier	
2, 3, 4		2,3, 4		2,3, 4	
1 changeo. cont. (AgSnO ₂)		1 changeo. cont. (AgSnO ₂)		1 changeo. cont. (AgSnO ₂)	
max. 300 Vdc / 400 Vac		max. 300 Vdc / 400 Vac		max. 300 Vdc / 400 Vac	
max. 6 A / max. 1500 VA		max. 6 mA / max. 1500 VA		max. 6 A / max. 1500 VA	
100 mA (at U = 10 V)		100 mA (at U = 10 V)		100 mA (at U = 10 V)	
max. 6 A		max. 6 A		max. 6 A	
see limit diagram		see limit diagram		see limit diagram	
20 x 10 ⁶ switching operations		20 x 10 ⁶ switching operations		20 x 10 ⁶ switching operations	
0.1 Hz		0.1 Hz		0.1 Hz	
300 V		300 V		300 V	
4 kV		4 kV		4 kV	
III		III		III	
2		2		2	
≥ 5.5 mm		≥ 5.5 mm		≥ 5.5 mm	
4 kV _{eff} / 1 min		4 kV _{eff} / 1 min		4 kV _{eff} / 1 min	
-25 °C...+50 °C		-25 °C...+50 °C		-25 °C...+50 °C	
-40 °C...+60 °C		-40 °C...+60 °C		-40 °C...+60 °C	
AWG 22...12		AWG 22...12		AWG 22...12	
1.5 mm ²		1.5 mm ²		1.5 mm ²	
CE, UL, CSA		CE, UL, CSA		CE, UL, CSA	
6 mm		6 mm		6 mm	
Type	Cat. No.	Type	Cat. No.	Type	Cat. No.
AP MCZ 1.5	8389030000	AP MCZ 1.5	8389030000	AP MCZ 1.5	8389030000
Page 305		Page 305		Page 305	

Relay Couplers in Component Housings Mini coupler DKR

These modules are used for protective separation of input signals and adjustment of signal levels

- Cost-effective solution for adjustment of power and potential
- Low input power
- Screw connection technology
- 6-mm width

DKR 5 Vdc

DKR 12 Vdc

DKR 24 Vac/dc

DKR 24 Vdc

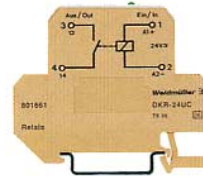

Schematic circuit diagram

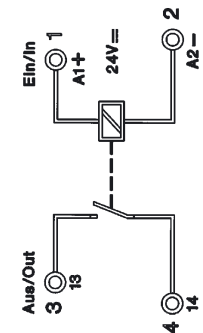
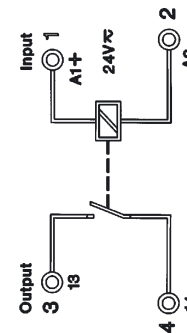
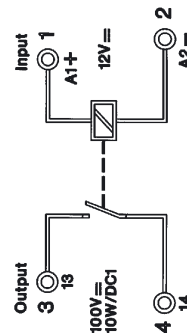
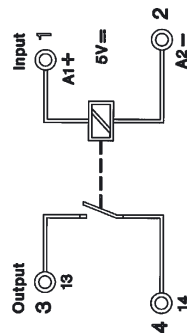

Ordering data	Type	Cat. No.	Type	Cat. No.	Type	Cat. No.	Type	Cat. No.
for TS 32	DKR 5 Vdc	8019600000	DKR 12 Vdc	8171100000	DKR 24 Vac/dc	8008110000	DKR 24 Vdc	8016620000
for TS 35	DKR 5 Vdc	8019610000			DKR 24 Vac/dc	8016610000	DKR 24 Vdc	8008170000
With combination foot TS 32/TS 35								
Technical data	Input: bottom		Input: bottom		Input: bottom		Input: bottom	
Input voltage	5 Vdc ±5 %		12 Vdc ±10 %		24 Vac/dc ±20 %		24 Vdc ±20 %	
Input current	12.5 mA		12 mA		11.5 mAac/9 mAdc		9.3 mA	
Input current, limited = SPS able								
Input power	65 mW		144 mW		300 mVA/220 mW		225 mW	
Pick-up lag	typ. 0.7...2.5 ms		typ. 0.7...2.5 ms		0.6...4.5 ms ac/0.9...1.3 ms dc		typ. 0.7...2.5 ms	
Turn off delay	typ. 0.2...2.0 ms		typ. 0.2...2.0 ms		12.7...25 ms ac/14.4...16.4 ms dc		typ. 0.2...2.0 ms	
Max. switch-on current	500 mA		500 mA		500 mA		500 mA	
Max. switching capacity	10 W/10 VA		10 W/10 VA		10 W/10 VA		10 W/10 VA	
Max. output voltage	100 V		175 V		170 V		100 V	
Max. output current	500 mA		500 mA		500 mA		500 mA	
Min. output current								
Max. switching frequency	200 Hz		25 Hz		5 Hz		20 Hz	
Contact material	RH/RU		RH/RU		RH/RU		RH/RU	
Contacts	1 normally-open contact		1 normally-open contact		1 normally-open contact		1 normally-open contact	
Service life	mechanical	10 ⁹ switching operations	10 ⁹ switching operations	10 ⁹ switching operations	10 ⁹ switching operations	10 ⁹ switching operations	10 ⁹ switching operations	10 ⁹ switching operations
	at I _L = 10 mA	5 x 10 ⁸ switching operations	5 x 10 ⁸ switching operations	5 x 10 ⁸ switching operations	5 x 10 ⁸ switching operations	5 x 10 ⁸ switching operations	5 x 10 ⁸ switching operations	5 x 10 ⁸ switching operations
Insulation coordination acc. to EN 50178	Rated voltage		Rated voltage		Rated voltage		Rated voltage	
	150 V		150 V		150 V		150 V	
	Rated impulse voltage		Rated impulse voltage		Rated impulse voltage		Rated impulse voltage	
	1.5 kV		1.5 kV		1.5 kV		1.5 kV	
	Overvoltage category		Overvoltage category		Overvoltage category		Overvoltage category	
	III		III		III		III	
	Pollution severity		Pollution severity		Pollution severity		Pollution severity	
	2		2		2		2	
	Clearances and creepage distances		Clearances and creepage distances		Clearances and creepage distances		Clearances and creepage distances	
	≥3 mm		≥3 mm		≥3 mm		≥3 mm	
Operating temperature	without clearance	-25 °C...+40 °C	-25 °C...+40 °C	-25 °C...+40 °C	-25 °C...+40 °C	-25 °C...+40 °C	-25 °C...+40 °C	-25 °C...+40 °C
	with clearance	-25 °C...+50 °C	-25 °C...+50 °C	-25 °C...+50 °C	-25 °C...+50 °C	-25 °C...+50 °C	-25 °C...+50 °C	-25 °C...+50 °C
Storage temperature		-40 °C...+60 °C	-40 °C...+60 °C	-40 °C...+60 °C	-40 °C...+60 °C	-40 °C...+60 °C	-40 °C...+60 °C	-40 °C...+60 °C
Conductor		AWG 22...12	AWG 22...12	AWG 22...12	AWG 22...12	AWG 22...12	AWG 22...12	AWG 22...12
Conductor cross-section		0.5...4 mm ²	0.5...4 mm ²	0.5...4 mm ²	0.5...4 mm ²	0.5...4 mm ²	0.5...4 mm ²	0.5...4 mm ²
Overall width		6 mm	6 mm	6 mm	6 mm	6 mm	6 mm	6 mm
Accessories	Type	Cat. No.	Type	Cat. No.	Type	Cat. No.	Type	Cat. No.
End plate	AP DKT4	0687560000	AP DKT4	0687560000	AP DKT4	0687560000	AP DKT4	0687560000
Further accessories, dimensions and connection data see	Page 305		Page 305		Page 305		Page 305	

Relay Couplers in Component Housings Mini coupler DKR

DKR 24 Vac/dc

DK5R-1U

DKR 24 Vdc

DKR 24 Vac/dc

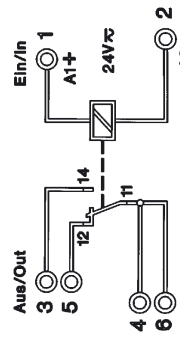
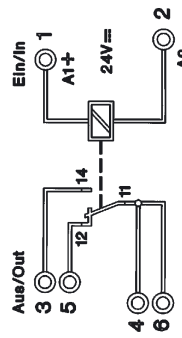
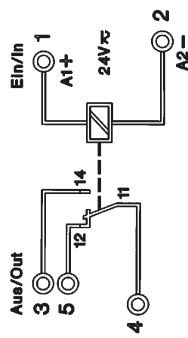
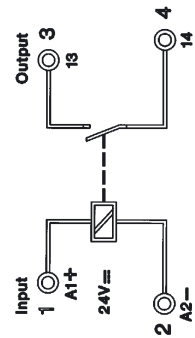
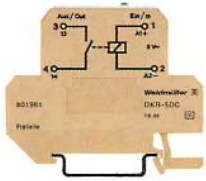

Type	Cat. No.	Type	Cat. No.	Type	Cat. No.	Type	Cat. No.
DKR 24 Vdc	8215620000	DK5R-1U	9454910000	DKR 24 Vdc	8181980000	DKR 24 Vac/dc	8181970000
Input: top		Input: bottom		Input: bottom		Input: bottom	
24 Vdc ±20 %		24 Vac/dc ±20 %		24 Vdc ±20 %		24 Vac/dc ±20 %	
9.3 mA		9 mAac/7 mAdc		11.5 mA		20 mAac/16 mAdc	
		max. 240 mA				max. 100 mA	
225 mW		6 ms		384 mW		480 mWac/400 mWdc	
typ. 0.7...2.5 ms		15 ms ac/dc					
typ. 0.2...2.0 ms							
500 mA		4 A		5 A		5 A	
10 W/10 VA		1.5 kVA/140 W		2 kVA/192 W		2 kVA/192 W	
175 Vac/dc		250 Vac/dc		250 Vac/dc		250 Vac/dc	
500 mA		6 A		8 A		8 A	
25 Hz		20 Hz		100 mA		100 mA	
RH/RU		Ag Ni		25 Hz		ac: 5 Hz dc: 25 Hz	
1 normally-open contact		1 changeover contact		AgCdO		AgCdO	
10 ⁹ switching operations		2x10 ⁷ switching operations		1 changeover contact		1 changeover contact	
5 x 10 ⁸ switching operations				≥10 ⁷ switching operations		≥10 ⁷ switching operations	
				≥3 x 10 ⁶ switching operations		≥3 x 10 ⁶ switching operations	
150 V		300 V					
1.5 kV		4 kV		300 V		300 V	
III		III		6 kV		6 kV	
2		2		IV		IV	
≥3 mm		≥8 mm		2		2	
				≥8 mm		≥8 mm	
-25 °C...+40 °C		-40 °C...+60 °C				-25 °C...+40 °C	
-25 °C...+50 °C		-40 °C...+60 °C		-25 °C...+40 °C		-25 °C...+50 °C	
-40 °C...+60 °C		-40 °C...+60 °C		-25 °C...+50 °C		-40 °C...+60 °C	
AWG 22...12		AWG 22...12		-40 °C...+60 °C		-40 °C...+60 °C	
0.5...4 mm ²		0.5...4 mm ²		AWG 22...12		AWG 22...12	
6 mm		6 mm		0.5...4 mm ²		0.5...4 mm ²	
				18 mm		18 mm	
Type	Cat. No.	Type	Cat. No.	Type	Cat. No.	Type	Cat. No.
AP DKT4	0687560000	AP DK5	8268870000	AP DKT4	0687560000	AP DKT4	0687560000
Page 305		Page 305		Page 305		Page 305	

Relay Coupler in Component Housings EG 2

with 1 NO or 1 NC

EGR EG 2 24 V
AC/DC voltage



EGR EG 2 24 V
Direct and alternating voltage



EGR EG 2 48 V



EGR EG 2 230 V
AC voltage



Schematic circuit diagram

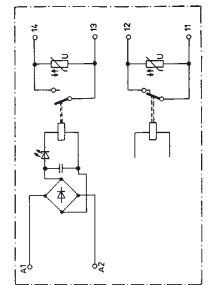
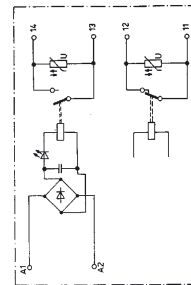
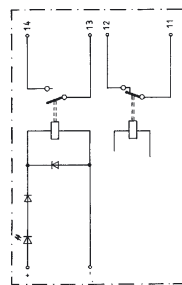

Ordering data

Type	Cat. No.
NC	0133560000¹⁾
NO	0133660000¹⁾

Type	Cat. No.
NC	0542660000
NO	0536260000

Type	Cat. No.
NC	0662460000
NO	0662660000

Type	Cat. No.
NC	0543660000
NO	0543860000

Rated data

Input voltage

Rated consumption – (W)	0.36 W
Rated consumption ~ (VA)	–
Drop-out current of the relay** (at 20 °C)	1.5 mA

Max. output voltage

Continuous current

Derating curve

a = mounted horizontally on rail without clearance
b = mounted horizontally on rail with clearance x 20 mm

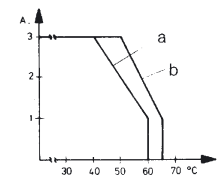
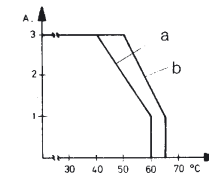
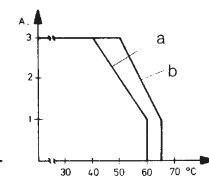
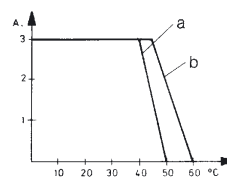
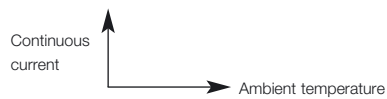

Switch-on current

Max. switching capacity with resistor load

Min. switching capacity/switching current

Bounce times

Switching times, typical

–, pick-up lag

–, turn off delay

Max. switching frequency

Contact material

Service life, mechanical

–, 24 V–, 1 A, resistive load

–, 230 V–, 3 A, resistive load

Status indicator

Storage temperature

Ambient temperature

–, mounted on rail without clearance

–, mounted on rail with clearance ≥ 20 mm

Approvals

Insulation coordination acc. to EN 50178

Overvoltage category

Pollution severity

Accessories, dimensions and connection data see

** Larger values on request

5 A

600 VA/120 W

40 μW

< 2 ms

< 5.3 ms

< 8.3 ms

50 Hz

AgNi, gold-plated

> 10⁷ switching operations

> 6 x 10⁵ switching operations

> 10⁵ switching operations

Green LED

–40 °C...+60 °C

–25 °C...+40 °C

–25 °C...+50 °C

CSA (013366)

III

3

Page 306, Fig. II

¹⁾ no output varistor

5 A

600 VA/120 W

40 μW

< 2 ms

< 8 ms

< 22 ms

30 Hz

AgNi, gold-plated

> 10⁷ switching operations

> 6 x 10⁵ switching operations

> 10⁵ switching operations

Green LED

–40 °C...+60 °C

–25 °C...+40 °C

–25 °C...+50 °C

Page 306, Fig. II

5 A

600 VA/120 W

40 μW

< 2 ms

< 9 ms

< 12 ms

37 Hz

AgNi, gold-plated

> 10⁷ switching operations

> 6 x 10⁵ switching operations

> 10⁵ switching operations

Green LED

–40 °C...+60 °C

–25 °C...+40 °C

–25 °C...+50 °C

Page 306, Fig. II

5 A

600 VA/120 W

40 μW

< 2 ms

< 5 ms

< 7 ms

40 Hz

AgNi, gold-plated

> 10⁷ switching operations

> 6 x 10⁵ switching operations

> 10⁵ switching operations

Green LED

–40 °C...+60 °C

–25 °C...+40 °C

–25 °C...+50 °C

Page 306, Fig. II

Relay Coupler in Component Housings EG 2

with 2.8-mm tab connection

EGR EG 2

DC voltage
2 changeover contacts



EGR EG 2

AC/DC voltage
2 changeover contacts



Schematic circuit diagram

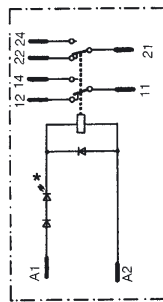

LED is parallel to coil in 12 V DC and 24 V DC versions

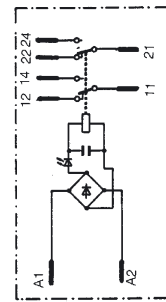

Ordering data

EGR 2 RT (12 V-)	0160160000
EGR 2 RT (24 V-)	0160260000

Type	Cat. No.
EGR 2 RT (12 V-)	0160160000
EGR 2 RT (24 V-)	0160260000

Type	Cat. No.
EGR 2 RT (48 V-)	0160360000
EGR 2 RT (115 V-)	0160460000

Type	Cat. No.
EGR 2 RT (24 V0)	0123060000
EGR 2 RT (48 V0)	0123260000

Type	Cat. No.
EGR 2 RT (115 V0)	0141360000
EGR 2 RT (230 V0)	0142460000

Rated data

Input voltage	12 V-	24 V-	48 V-	115 V-	24 V0	48 V0	115 V0	230 V0
Rated consumption - (W)	0.61 W	0.54 W	0.65 W	0.6 W	0.7 W	0.7 W	0.6 W	1.2 W
Rated consumption ~ (VA)	-	-	-	-	1 VA	0.9 VA	0.6 VA	1.2 VA
Drop-out current of the relay** (at 20 °C)	12 mA	5.5 mA	2.5 mA	1 mA	3.5 mA-8 mA-	2 mA-3.5 mA-	1 mA-1 mA-	1 mA
Max. output voltage	250 V				250 V			
Continuous current	5 A				5 A			

Derating curve
a = mounted horizontally on rail without clearance
b = mounted horizontally on rail with clearance x 20 mm

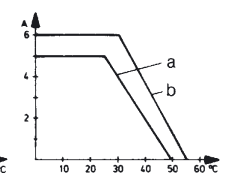
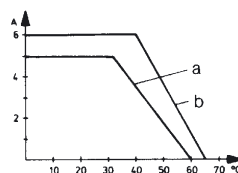
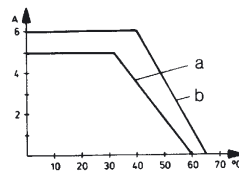
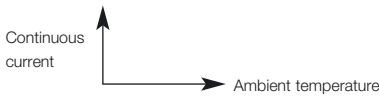

Switch-on current	15 A/200 ms
Max. switching capacity with resistor load	1100 VA/144 W
Min. braking capacity/switching current	5 A
Bounce times	4 ms
Switching times, typical	
- , pick-up lag	16 ms 22 ms
- , turn off delay	20 ms 15 ms
Max. switching frequency	20 Hz 20 Hz
Contact material	Ag, gold-flashed
Service life, mechanical	30 x 10 ⁶
- , 24 V-, 1 A, resistive load	10 ⁵ (1100 VA, cos φ = 1)
- , 230 V-, 3 A, resistive load	
Status indicator	Red LED
Storage temperature	-40 °C...+85 °C
Ambient temperature	
- , mounted on rail without clearance	-25 °C...+40 °C
- , mounted on rail with clearance ≥ 20 mm	

Type	Cat. No.
EGR 2 RT (12 V-)	0160160000
EGR 2 RT (24 V-)	0160260000
EGR 2 RT (48 V-)	0160360000
EGR 2 RT (115 V-)	0160460000
Switch-on current	15 A/200 ms
Max. switching capacity with resistor load	1100 VA/144 W
Min. braking capacity/switching current	5 A
Bounce times	4 ms
Switching times, typical	
- , pick-up lag	18 ms 14 ms
- , turn off delay	16 ms 23 ms
Max. switching frequency	27 Hz 24 Hz
Contact material	Ag, gold-flashed
Service life, mechanical	30 x 10 ⁶
- , 24 V-, 1 A, resistive load	10 ⁵ (1100 VA, cos φ = 1)
- , 230 V-, 3 A, resistive load	
Status indicator	Red LED
Storage temperature	-40 °C...+85 °C
Ambient temperature	
- , mounted on rail without clearance	-25 °C...+40 °C
- , mounted on rail with clearance ≥ 20 mm	

Type	Cat. No.
EGR 2 RT (24 V0)	0123060000
EGR 2 RT (48 V0)	0123260000
Switch-on current	15 A/200 ms
Max. switching capacity with resistor load	1100 VA/144 W
Min. braking capacity/switching current	5 A
Bounce times	4 ms
Switching times, typical	
- , pick-up lag	23 ms 18 ms
- , turn off delay	25 ms 19 ms
Max. switching frequency	19 Hz 21 Hz
Contact material	Ag, gold-flashed
Service life, mechanical	30 x 10 ⁶
- , 24 V-, 1 A, resistive load	10 ⁵ (1100 VA, cos φ = 1)
- , 230 V-, 3 A, resistive load	
Status indicator	Red LED
Storage temperature	-40 °C...+85 °C
Ambient temperature	
- , mounted on rail without clearance	-25 °C...+40 °C
- , mounted on rail with clearance ≥ 20 mm	

Type	Cat. No.
EGR 2 RT (115 V0)	0141360000
EGR 2 RT (230 V0)	0142460000
Switch-on current	15 A/200 ms
Max. switching capacity with resistor load	1100 VA/144 W
Min. braking capacity/switching current	5 A
Bounce times	4 ms
Switching times, typical	
- , pick-up lag	17 ms 13 ms
- , turn off delay	17 ms 18 ms
Max. switching frequency	24 Hz 22 Hz
Contact material	Ag, gold-flashed
Service life, mechanical	30 x 10 ⁶
- , 24 V-, 1 A, resistive load	10 ⁵ (1100 VA, cos φ = 1)
- , 230 V-, 3 A, resistive load	
Status indicator	Red LED
Storage temperature	-40 °C...+85 °C
Ambient temperature	
- , mounted on rail without clearance	-25 °C...+40 °C
- , mounted on rail with clearance ≥ 20 mm	

Type	Cat. No.
EGR 2 RT (115 V0)	0141360000
EGR 2 RT (230 V0)	0142460000
Switch-on current	15 A/200 ms
Max. switching capacity with resistor load	1100 VA/144 W
Min. braking capacity/switching current	5 A
Bounce times	4 ms
Switching times, typical	
- , pick-up lag	17 ms 13 ms
- , turn off delay	17 ms 18 ms
Max. switching frequency	24 Hz 22 Hz
Contact material	Ag, gold-flashed
Service life, mechanical	30 x 10 ⁶
- , 24 V-, 1 A, resistive load	10 ⁵ (1100 VA, cos φ = 1)
- , 230 V-, 3 A, resistive load	
Status indicator	Red LED
Storage temperature	-40 °C...+85 °C
Ambient temperature	
- , mounted on rail without clearance	-25 °C...+40 °C
- , mounted on rail with clearance ≥ 20 mm	

Insulation coordination acc. to EN 50178

Overvoltage category	III
Pollution severity	2
Accessories, dimensions and connection data see	Page 306, Fig. III

Overvoltage category	III
Pollution severity	2
Accessories, dimensions and connection data see	Page 306, Fig. III

Overvoltage category	III
Pollution severity	2
Accessories, dimensions and connection data see	Page 306, Fig. III

Overvoltage category	III
Pollution severity	2
Accessories, dimensions and connection data see	Page 306, Fig. III

Overvoltage category	III
Pollution severity	2
Accessories, dimensions and connection data see	Page 306, Fig. III

** Larger values on request

WAVESERIES Relay Coupler in Component Housings

With 1 changeover contact

Relay couplers in the WAVEBOX

- Independent connection technology
 - pluggable connection unit
 - screw or tension clamp technology
- Fast commissioning and after-sales-service service
 - pluggable PCBs
- Save wiring tasks
 - cross-connections possible at input and output

WRS 1 2.4-24 VDC

WRS 1 24 VDC

WRS 1 24/48 VUC

WRS 1 24/60 VUC



Schematic circuit diagram

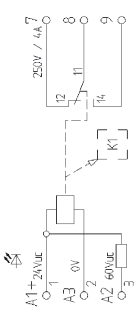
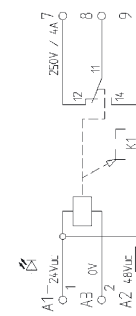
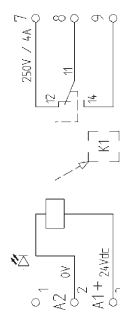
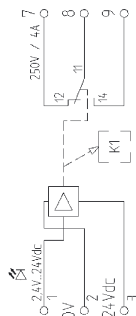

	Type	Cat. No.	Type	Cat. No.	Type	Cat. No.	Type	Cat. No.
Ordering data								
Screw connection	WRS 1 2.4-24 Vdc	8275320000	WRS 1 24 Vdc	8275350000	WRS 1 24/48 Vuc	8286280000	WRS 1 24/60 Vuc	8418210000
Tension clamp connection	WRZ 1	8430170000	WRZ 1	8430180000	WRZ 1	8430190000	WRZ 1	8430200000
Input								
Input voltage	2.4...24 Vdc +10 %		24 Vdc±10 %		24 Vuc±10 % / 48 Vuc±10%		24 Vuc±10% / 60 Vuc±10%	
Input current	4.6 mAdc ±15% at Ue 12 V		9 mAdc±15%		14 mAuc±15% at Ue 24 V 14 mAuc±15% at Ue 48V		11 mAac±15% at Ue=60 V 10 mAac±15% at Ue=60 V 10.2 mAac±15% at Ue=24 V 9 mAac±15% at Ue=24 V	
Input power	6 mW ±15% at Ue 2.4 V		220 mW±15%		0.5 VA (W)±15% at Ue=48V 0.35 VA (W)±15% at Ue=24V		0.7 VA ±15% at Ue=60 V 0.34 VA±15% at Ue=24 V 0.6 W ±15% at Ue=60 V 0.22 W±15% at Ue=24 V	
Output								
Switching voltage	max. 150 Vdc / 250 Vac		max. 150 Vdc / 250 Vac		max. 150 Vdc / 250 Vac		max. 150 Vdc / 250 Vac	
Continuous current AC / Switching power AC	max. 5 A / max. 1250 VA*		max. 5 A / max. 1250 VA*		max. 5 A / max. 1250 VA*		max. 5 A / max. 1250 VA*	
Switch-on current	max. 10 A		max. 10 A		max. 10 A		max. 10 A	
Min. switching	100 mA/5 Vdc		100 mA/5 Vdc		100 mA/5Vdc		100 mA/5 Vdc	
Contact material	Ag-alloy		Ag-alloy		Ag-alloy		Ag-alloy	
Contact resistance (when new)	max. 30 mΩ / max. 100 mΩ at 1 A/6 Vdc		max. 30 mΩ / max. 100 mΩ at 1 A/6 Vdc		max. 30 mΩ / max. 100 mΩ at 1 A/6 Vdc		max. 30 mΩ / max. 100 mΩ at 1 A / 6 Vdc	
Pick-up delay at nominal voltage	typ. 7 ms (NO) / 4.5 ms (NC)		typ. 7 ms (NO) / 4.5 ms (NC)		typ. 7 ms (NO) / 4.5 ms (NC)		typ. 5.4 ms (NO) / 4.2 ms (NC)	
Turn off delay	typ. 6.3 ms (NO) / 5.5 ms (NC)		typ. 6.3 ms (NO) / 5.5 ms (NC)		typ. 6.3 ms (NO) / 5.5 ms (NC)		typ. 4.4 ms (NO) / 5.4 ms (NC)	
Mechanical service life	20 x 10 ⁶ switching operations		20 x 10 ⁶ switching operations		20 x 10 ⁶ switching operations		20 x 10 ⁶ switching operations	
Electrical service life	150 x 10 ³ switching operations		150 x 10 ³ switching operations		1.5 x 10 ⁵ switching operations		150 x 10 ³ switching operations	
Max. switching frequency at nominal voltage	0.1 Hz		0.1 Hz		0.1 Hz		0.1 Hz	
Ambient temperature	-25 °C...+50 °C		-25 °C...+50 °C		-25 °C...+50 °C		-25 °C...+50 °C	
Storage temperature	-40 °C...+60 °C		-40 °C...+60 °C		-40 °C...+60 °C		-40 °C...+60 °C	
Approvals	UL/CSA		UL/CSA		UL/CSA		UL/CSA	
Insulation coordination acc. to EN 50178								
Rated voltage	300 V		300 V		300 V		300 V	
Rated impulse voltage	4 kV (1.2/50 μ)		4 kV (1.2/50 μ)		4 kV (1.2/50 μ)		4 kV (1.2/50 μ)	
Overtoltage category	III		III		III		III	
Pollution severity	2		2		2		2	
Implemented clearance and creepage path	≥ 5.5 mm		≥ 5.5 mm		≥ 5.5 mm		≥ 5.5 mm	
Insulation and voltage strength								
Insulation and voltage strength of entire circuit to mounting rail	4 kV _{eff} 1 min		4 kV _{eff} 1 min		4 kV _{eff} 1 min		4 kV _{eff} 1 min	
Testing								
Input/output high voltage test	4 kV _{eff} 1 s		4 kV _{eff} 1 s		4 kV _{eff} 1 s		4 kV _{eff} 1 s	
Accessories, dimensions and connection data see	Page 298 + 308		Page 298 + 308		Page 298 + 308		Page 298 + 308	

* at ambient temperature 20°C

WAVESERIES Relay Coupler in Component Housings

WRS 1 24/115 VUC **WRS 1 24 VUC**
230 VAC

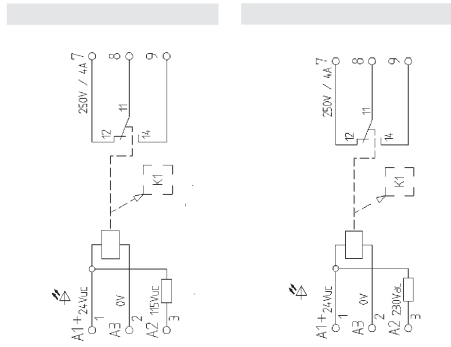

Type	Cat. No.	Type	Cat. No.
WRS 1 24/115 Vuc	8418220000	WRS 1 24 Vuc/230 Vac	8418230000
WRZ 1	8430210000	WRZ 1	8430220000

24 Vuc±10% / 115 Vuc±10%	24 Vuc±10% / 230 Vuc±10%
11 mAac±15% at Ue=115 V	15 mAac±15% at Ue=230 V
10.5mAdc±15% at Ue=115 V	14 mAac±15% at Ue=24 V
10.2 mAac±15% at Ue=24 V	13 mAdc±15% at Ue=24 V
9 mAdc±15% at Ue=24 V	
1.3 VA ±15% at Ue=115 V	3.5 VA ±15% at Ue=230 V
0.34 VA±15% at Ue=24 V	0.34 VA±15% at Ue=24 V
1.2 W ±15% at Ue=115 V	0.32 W±15% at Ue=24 V
0.22 W±15% at Ue=24 V	

max. 150 Vdc/250 Vac	max. 150 Vdc/250 Vac
max. 5 A/max. 1250 VA*	max. 5 A/max. 1250 VA*
max. 10 A	max. 10 A
100 mA/5 Vdc	100 mA/5 Vdc
Ag-alloy	Ag-alloy
max. 30 mΩ/max. 100 mΩ at 1 A / 6 Vdc	max. 30 mΩ/max. 100 mΩ at 1 A / 6 Vdc
typ. 5.4 ms (NO) / 4.2 ms (NC)	typ. 5.4 ms (NO) / 4.2 ms (NC)
typ. 4.4 ms (NO) / 5.4 ms (NC)	typ. 4.4 ms (NO) / 5.4 ms (NC)
20 x 10 ⁶ switching operations	20 x 10 ⁶ switching operations
150 x 10 ³ switching operations	150 x 10 ³ switching operations
0.1 Hz	0.1 Hz
-25 °C...+50 °C	-25 °C...+50 °C
-40 °C...+60 °C	-40 °C...+60 °C
UL/CSA	UL/CSA

300 V	300 V
4 kV (1.2/50 μ)	4 kV (1.2/50 μ)
III	III
2	2
≥ 5.5 mm	≥ 5.5 mm
4 kV _{eff} 1 min	4 kV _{eff} 1 min

4 kV _{eff} 1 s	4 kV _{eff} 1 s
Page 298 + 308	Page 298 + 308

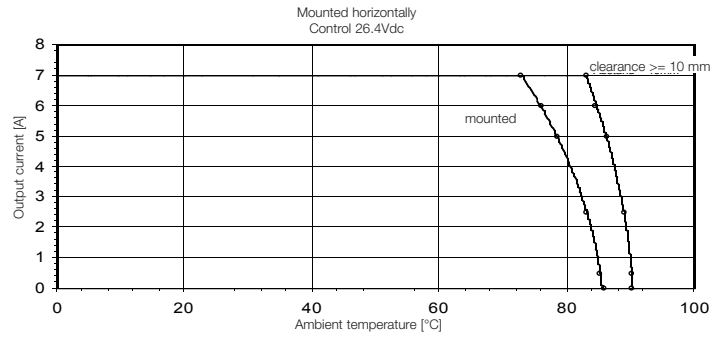

WRS 1 2.4-24 VDC • 8275320000

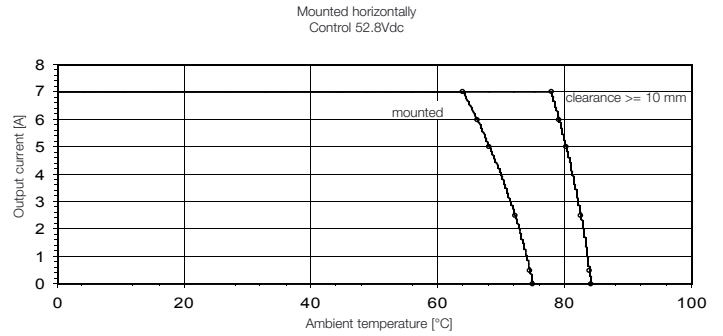

WRS 1 24/48 VUC • 8286280000

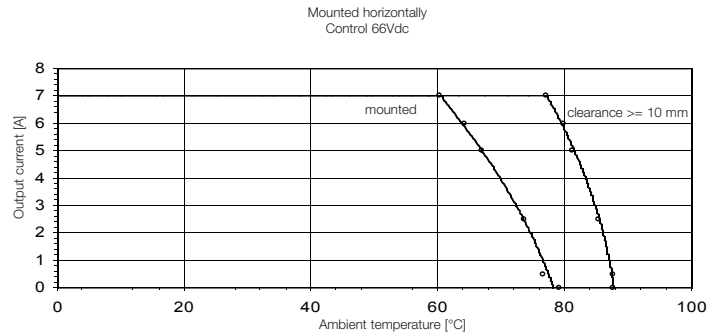

WRS 1 24/60 VUC • 8418210000

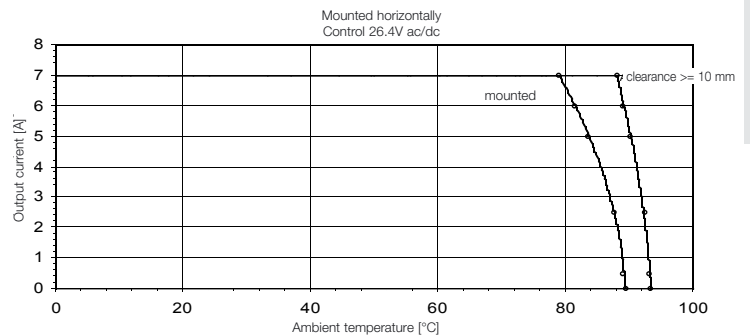

WRS 1 24/115 VUC • 8418220000

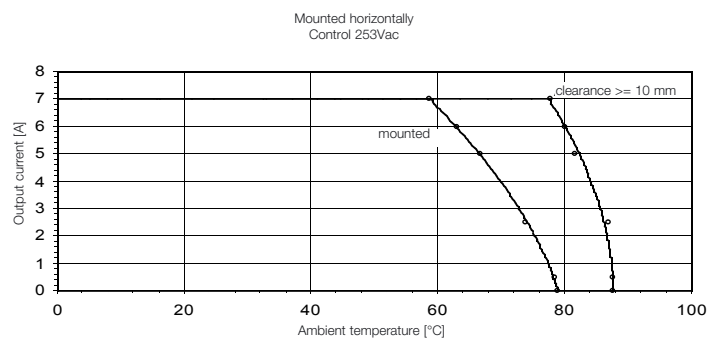

WRS 1 24 VUC/230 VAC • 8418230000

WAVESERIES Relay Coupler in Component Housings

with 2 NO contacts

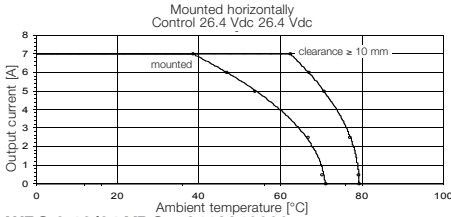

WRS 2 12/24 VDC • 8418240000

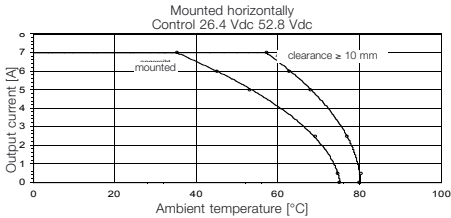

WRS 2 24/48 VUC • 8418250000

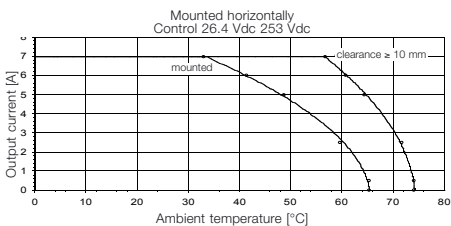

WRS 2 115 VUC/ 230 VAC • 8418260000

WRS 2 12/24 VDC



WRS 2 24/48 VUC



WRS 2 115 VUC/ 230 VAC



Schematic circuit diagram

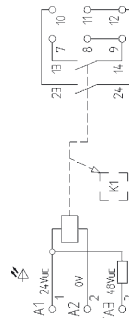
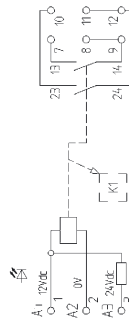

Ordering data

Screw connection

Tension clamp connection

Input

Input voltage

Input current

Input power

Output

Switching voltage

Continuous current AC / Switching power AC

Switch-on current

Min. switching

Contact material

Contact resistance (when new)

Pick-up delay at nominal voltage

Turn off delay

Mechanical service life

Electrical service life

Max. switching frequency at nominal voltage

Ambient temperature

Storage temperature

Approvals

Insulation coordination acc. to EN 50178

Rated voltage

Rated impulse voltage

Overtoltage category

Pollution severity

Implemented clearance and creepage path

Insulation and voltage strength

Insulation and voltage strength of entire circuit to mounting rail

Testing

Input/output high voltage test

Accessories, dimensions and connection data see

* at ambient temperature 20°C

Type Cat. No.

WRS 2 12/24 Vdc

8418240000

WRZ 2 8430230000

12 Vdc±10 % / 24 Vdc±10 %

21 mAac±15% at Ue=24 V

20 mAac±15% bei Ue=12 V

0.5 W±15% at Ue=24 V

0.24 W±15% at Ue=12 V

max. 250 Vdc / 250 Vac

(UL -> 13300/12300)

max. 5 A / max. 1250 VA*

max. 8 A

100 mA / 5 Vdc

AgSnO₂

max. 30 mΩ/max. 100 mΩ

at 1 A/6 Vdc

typ. 5 ms

typ. 6.3 ms (NO) /

5.5 ms (NC)

50 x 10⁶ switching operations

1 x 10⁵ switching operations

0.1 Hz

-25 °C...+50 °C

-40 °C...+60 °C

UL/CSA

300 V

4 kV (1.2/50 μ)

III

2

≥ 8 mm

4 kV_{eff} 1 min

4 kV_{eff} 1 s

Page 298 + 308

Type Cat. No.

WRS 2 24/48 Vuc

8418250000

WRZ 2 8430240000

24 Vuc±10 % / 48 Vuc±10 %

10 mAac±15% at Ue=48 V

11.5 mAac±15% at Ue=24 V

8.5 mAac±15% at Ue=48 V

7.2 mAac±15% at Ue=24 V

0.48 VA±15% at Ue=48 V

0.21 VA±15% at Ue=24 V

0.4 W±15% at Ue=48 V

0.17 W±15% at Ue=24 V

max. 250 Vdc / 250 Vac

(UL -> 13300/12300)

max. 5 A / max. 1250 VA*

max. 8 A

100 mA / 5 Vdc

AgSnO₂

max. 30 mΩ/max. 100 mΩ

at 1 A/6 Vdc

typ. 5 ms

50 x 10⁶ switching operations

1 x 10⁵ switching operations

0.1 Hz

-25 °C...+50 °C

-40 °C...+60 °C

UL/CSA

300 V

4 kV (1.2/50 μ)

III

2

≥ 8 mm

4 kV_{eff} 1 min

4 kV_{eff} 1 s

Page 298 + 308

Type Cat. No.

WRS 2 115 Vuc/230 Vac

8418260000

WRZ 2 8430250000

115 Vuc±10% / 230 Vac±10 %

11 mAac±15% at Ue=230 V

8.5 mAac±15% at Ue=115 V

8 mAac±15% at Ue=115 V

2.5 VA±15% at Ue=230 V

1 VA±15% at Ue=115 V

0.9 W±15% at Ue=115 V

max. 250 Vdc / 250 Vac

(UL -> 13300/12300)

max. 5 A / max. 1250 VA*

max. 8 A

100 mA / 5 Vdc

AgSnO₂

max. 30 mΩ/max. 100 mΩ

at 1 A/6 Vdc

50 x 10⁶ switching operations

1 x 10⁵ switching operations

0.1 Hz

-25 °C...+50 °C

-40 °C...+60 °C

UL/CSA (nur 115 Vuc)

300 V

4 kV (1.2/50 μ)

III

2

≥ 8 mm

4 kV_{eff} 1 min

4 kV_{eff} 1 s

Page 298 + 308

WAVESERIES Relay Coupler in Component Housings

with 1NC / 1 NO

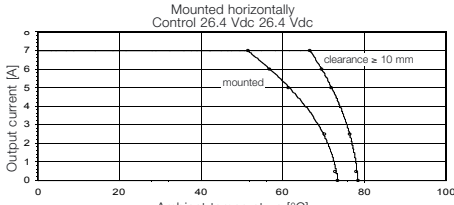

WRS 2 12/24 VDC • 8418270000

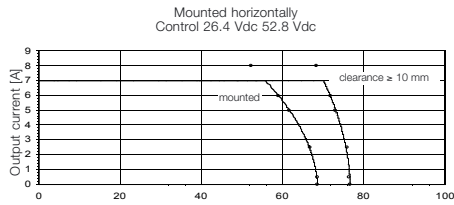

WRS 2 24/48 VUC • 8418280000

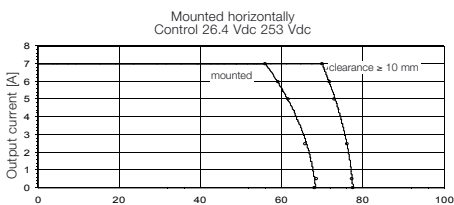

WRS 2 115 VUC/230 VAC • 8418290000

WRS 2 12/24 VDC

WRS 2 24/48 VUC

WRS 2 115 VUC/
230 VAC



Schematic circuit diagram

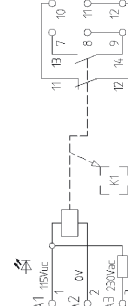
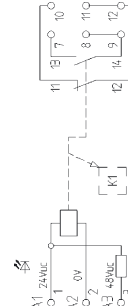
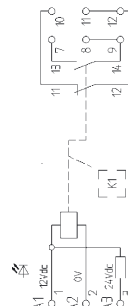

Ordering data

Screw connection

Tension clamp connection

Input

Input voltage

Input current

Input power

Output

Switching voltage

Continuous current AC / Switching power AC

Switch-on current

Min. switching

Contact material

Contact resistance (when new)

Pick-up delay at nominal voltage

Turn off delay

Mechanical service life

Electrical service life

Max. switching frequency at nominal voltage

Ambient temperature

Storage temperature

Approvals

Insulation coordination acc. to EN 50178

Rated voltage

Rated impulse voltage

Overtoltage category

Pollution severity

Implemented clearance and creepage path

Insulation and voltage strength

Insulation and voltage strength of entire circuit to mounting rail

Testing

Input/output high voltage test

Accessories, dimensions and connection data see

* at ambient temperature 20°C

Type	Cat. No.
WRS 2 12/24 Vdc	8418270000
WRZ 2	8430260000

Type	Cat. No.
WRS 2 24/48 Vuc	8418280000
WRZ 2	8430270000

Type	Cat. No.
WRS 2 115 Vuc/230 Vac	8418290000
WRZ 2	8430280000

12 Vdc±10% / 24 Vdc±10%
19.7 mAdc±15% at Ue=12 V
20.5 mAdc±15% at Ue=24 V

0.5 W±15% at Ue=24 V
0.24 W±15% at Ue=12 V

max. 250 Vdc/250 Vac
max. 5 A/max. 1250 VA*
max. 8 A
100 mA/5 V
AgSnO₂
max. 30 mΩ/max. 100 mΩ
at 1 A/6 Vdc

typ. 5ms

50 x 10⁶ switching operations
1 x 10⁵ switching operations
0.1 Hz
-25 °C...+50 °C
-40 °C...+60 °C
UL/CSA

300 V
4 kV (1.2/50 μ)
III
2
≥ 8 mm

4 kV_{eff} 1 min

4 kV_{eff} 1 s

Page 298 + 308

24 Vuc±10% / 48 Vuc±10%
10 mAac±15% at Ue=48 V
11.5 mAac±15% at Ue=24 V
8.5 mAdc±15% at Ue=48 V
7.2 mAdc±15% bei Ue=24 V

0.48 VA±15% at Ue=48 V
0.21 VA±15% at Ue=24 V
0.4 W±15% at Ue=48 V
0.17 W±15% at Ue=24 V

max. 250 Vdc/250 Vac
max. 5 A/max. 1250 VA*
max. 8 A
100 mA/5 V
AgSnO₂
max. 30 mΩ/max. 100 mΩ
at 1 A/6 Vdc

50 x 10⁶ switching operations
1 x 10⁵ switching operations
0.1 Hz
-25 °C...+50 °C
-40 °C...+60 °C
UL/CSA

300 V
4 kV (1.2/50 μ)
III
2
≥ 8 mm

4 kV_{eff} 1 min

4 kV_{eff} 1 s

Page 298 + 308

115 Vuc±10% / 230 Vac±10%
11 mAac±15% at Ue=230 V
10 mAac±15% at Ue=115 V
8 mAdc±15% at Ue=115 V

2.5 VA±15% at Ue=230 V
1 VA±15% at Ue=115 V
0.9 W±15% at Ue=115 V

max. 250 Vdc/250 Vac
max. 5 A/max. 1250 VA*
max. 8 A
100 mA/5 V
AgSnO₂
max. 30 mΩ/max. 100 mΩ
at 1 A/6 Vdc

50 x 10⁶ switching operations
1 x 10⁵ switching operations
0.1 Hz
-25 °C...+50 °C
-40 °C...+60 °C
UL/CSA (nur 115 Vuc)

300 V
4 kV (1.2/50 μ)
III
2
≥ 8 mm

4 kV_{eff} 1 min

4 kV_{eff} 1 s

Page 298 + 308

WAVESERIES Relay Coupler in Component Housings

with 2 changeover contacts

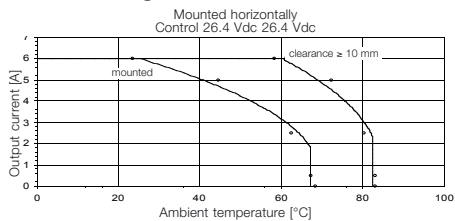

WRS 2 12/24 VDC • 8418300000

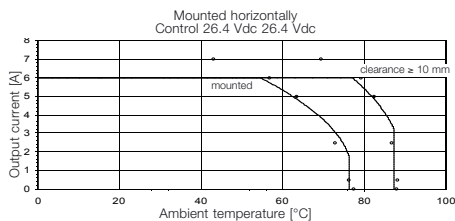

WRS 2 24/48 VUC • 8418310000

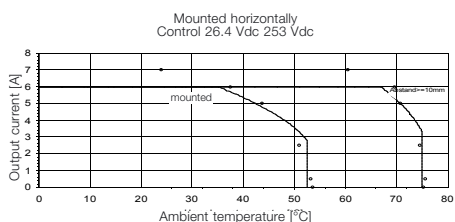

WRS 2 24 VUC/ 230 VAC • 8418320000

WRS 2 12/24 VDC



WRS 2 24/48 VUC



WRS 2 24 VUC/ 230 VAC



Schematic circuit diagram

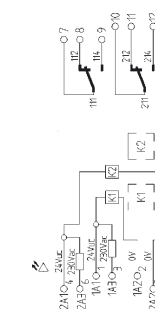
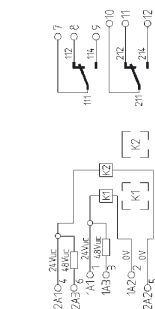
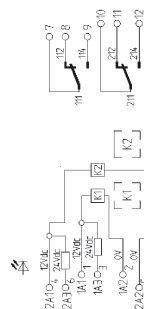

Ordering data

Screw connection

Tension clamp connection

Input

Input voltage

Input current

Input power

Output

Switching voltage

Continuous current AC / Switching power AC

Switch-on current

Min. switching

Contact material

Contact resistance (when new)

Pick-up delay at nominal voltage

Turn off delay

Mechanical service life

Electrical service life

Max. switching frequency at nominal voltage

Ambient temperature

Storage temperature

Approvals

Type Cat. No.

WRS 2 12/24 Vdc

8418300000

WRZ 2 8430290000

12 Vdc±10% /24 Vdc±10 %

21 mA±15% at Ue=12 V

22 mA±15% at Ue=24 V

0.26 W±15% at Ue=12 V

0.53 W±15% at Ue=24 V

max. 150 Vdc /250 Vac

max. 5 A/max. 1250 VA*

max. 10 A

100 mA/5 Vdc

Ag-alloy

max. 30 mΩ / max. 100 mΩ

at 1 A / 6 Vdc

typ. 6.5 ms (NO) /

4.5 ms (NC)

typ. 8 ms (NO) /

11 ms (NC)

20 x 10⁶ switching operations

1.5 x 10⁵ switching operations

0.1 Hz

-25 °C...+50 °C

-40 °C...+60 °C

UL/CSA

Type Cat. No.

WRS 2 24/48 Vuc

8418310000

WRZ 2 8430300000

24 Vuc±10% /48 Vuc±10 %

14 mA±15% at Ue=48 V

14 mA±15% at Ue=24 V

0.7 VA(W)±15% at Ue=48 V

0.35 VA(W)±15% at Ue=24 V

max. 150 Vdc /250 Vac

max. 5 A/max. 1250 VA*

max. 10 A

100 mA/5 Vdc

Ag-alloy

max. 30 mΩ / max. 100 mΩ

at 1 A / 6 Vdc

typ. 6.5 ms (NO) /

4.5 ms (NC)

typ. 8 ms (NO)/

11 ms (NC)

20 x 10⁶ switching operations

1.5 x 10⁵ switching operations

0.1 Hz

-25 °C...+50 °C

-40 °C...+60 °C

UL/CSA

Type Cat. No.

WRS 2 24 VUC/230 Vac

8418320000

WRZ 2 8430310000

24 Vuc±10% /230 Vac±10%

15 mA±15% at Ue=230 V

14 mA±15% at Ue=24 V

0.35 W±15% at Ue=24 V

3.45 VA ±15% at Ue=230 V

max. 150 Vdc /250 Vac

max. 5 A/max. 1250 VA*

max. 10 A

100 mA / 5 Vdc

Ag-alloy

max. 30 mΩ / max. 100 mΩ

at 1 A / 6 Vdc

typ. 6 ms (NO)/4.2 ms

(NO)/Eingang: 24 Vuc/230 Vac

typ. 4.4 ms (NO)/

5.4 ms (NC)

20 x 10⁶ switching operations

150 x 10³ switching operations

0.1 Hz

-25 °C...+50 °C

-40 °C...+60 °C

Insulation coordination acc. to EN 50178

Rated voltage

Rated impulse voltage

Oversvoltage category

Pollution severity

Implemented clearance and creepage path

300 V

4 kV (1.2/50 μ)

III

2

≥ 5.5 mm

300 V

4 kV (1.2/50 μ)

III

2

≥ 5.5 mm

300 V

4 kV (1.2/50 μ)

III

2

≥ 5.5 mm

Insulation and voltage strength

Insulation and voltage strength of entire circuit to mounting rail

4 kV_{eff} 1 min

4 kV_{eff} 1 min

4 kV_{eff} 1 min

Testing

Input/output high voltage test

Accessories, dimensions and connection data see

* at ambient temperature 20°C

4 kV_{eff} 1 s

Page 298 + 308

4 kV_{eff} 1 s

Page 298 + 308

4 kV_{eff} 1 s

Page 298 + 308

WAVESERIES Relay Coupler in Component Housings

with 3 NO contacts

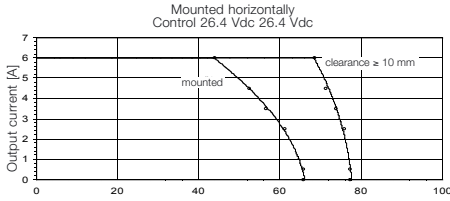

WRS 2 24 VUC • 8418330000

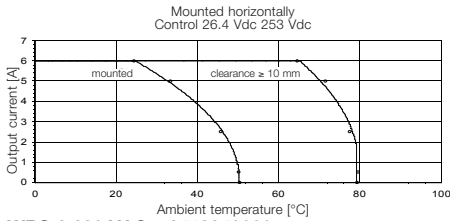

WRS 2 230 VAC • 8418340000

WRS 2 24 VUC



WRS 2 230 VAC



Schematic circuit diagram

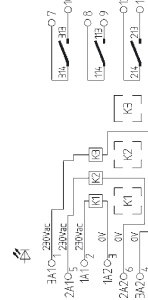

Ordering data	
Screw connection	
Tension clamp connection	

Type	Cat. No.
WRS 2 24 Vuc	8418330000
WRZ 2	8430320000

Type	Cat. No.
WRS 2 230 Vac	8418340000
WRZ 2	8430330000

Input	
Input voltage	3fach 24 Vac ±10 %
Input current	10.5 mAac ±15 % at U _{nom} (per channel)

Input voltage	3 x 230 Vac ±10 %
Input current	10.3 mAac ±15 % at U _{nom} (per channel)

Input power	0.3 VA ±15 % (per channel) 0.25 W ±15 %
-------------	--------------------------------------------

Input power	2.4 VA ±15 % (per channel)
-------------	----------------------------

Output	
Switching voltage	max. 250 Vdc /250 Vac
Continuous current AC / Switching power AC	max. 4 A/max. 1500 VA*
Switch-on current	max. 6 A
Min. switching	12 V/10 mA
Contact material	AgSnO ₂
Contact resistance (when new)	max. 100 mΩ at 1 A/24 Vdc
Pick-up delay at nominal voltage	typ. 5 ms
Turn off delay	typ. 21 ms
Mechanical service life	20 x 10 ⁶ switching operations
Electrical service life	1 x 10 ⁵ switching operations
Max. switching frequency at nominal voltage	0.1 Hz
Ambient temperature	-25 °C...+50 °C
Storage temperature	-40 °C...+60 °C
Approvals	UL/CSA

Switching voltage	max. 250 Vdc / 250 Vac
Continuous current AC / Switching power AC	max. 4 A/max. 1500 VA*
Switch-on current	max. 6 A
Min. switching	12 V/10 mA
Contact material	AgSnO ₂
Contact resistance (when new)	max. 100 mΩ at 1 A/24 Vdc
Pick-up delay at nominal voltage	typ. 8 ms
Turn off delay	typ. 11 ms
Mechanical service life	20 x 10 ⁶ switching operations
Electrical service life	1 x 10 ⁵ switching operations
Max. switching frequency at nominal voltage	0.1 Hz
Ambient temperature	-25 °C...+50 °C
Storage temperature	-40 °C...+60 °C

Insulation coordination acc. to EN 50178	
Rated voltage	300 V
Rated impulse voltage	4 kV (1.2/50 μ)
Overtoltage category	III
Pollution severity	2
Implemented clearance and creepage path	≥ 5.5 mm

Rated voltage	300 V
Rated impulse voltage	4 kV (1.2/50 μ)
Overtoltage category	III
Pollution severity	2
Implemented clearance and creepage path	≥ 5.5 mm

Insulation and voltage strength	
Insulation and voltage strength of entire circuit to mounting rail	4 kV _{eff} 1 min

Insulation and voltage strength of entire circuit to mounting rail	4 kV _{eff} 1 min
--------------------------------------------------------------------	---------------------------

Testing	
Input/output high voltage test	4 kV _{eff} 1 s
Accessories, dimensions and connection data see	Page 298 + 308

Input/output high voltage test	4 kV _{eff} 1 s
Accessories, dimensions and connection data see	Page 298 + 308

* at ambient temperature 20°C

Relay Couplers in Components Housings EG 7

- Plugs on to locking socket RS EG 7 with combination foot TS 32, 35
- Overall width: 10 mm
- With combination foot for TS 15, TS 32 or TS 35
- Versions with 12 V, 24 V and 48 V fulfil protective separation in accordance with VDE 0160, Part 101
- **All EGR EG 7 and RST EG 7 are approved by Germanischer Lloyd. Approval No. 35962 HH**

**EGR EG 7
RST EG 7
RS EG 7**



EGR EG 7



RST EG 7

RS EG 7

Schematic circuit diagram

Derating curve

- a = mounted horizontally on rail without clearance
- b = mounted horizontally on rail, rowed with clearances

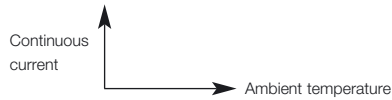

12 V0

24 V-

24 V-

24 V0

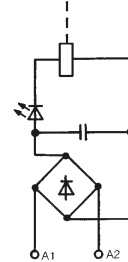
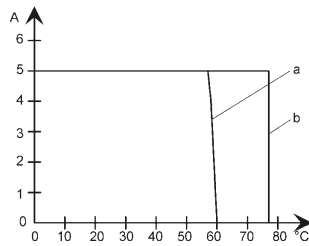

Ordering data

Combination foot for TS 15, TS 32, TS 35	1 NO
	1 NC
EGR EG 7 spare relays, without connection unit	
Plug-in relay-coupl., without engagem. socket, 1 changeo. cont.	
Engage.socket f. plug-in relay coupler w. combin.foot TS 32, 35	

Rated data of the coil

Input voltage	12 V0 +15 % -10 %
Rated consumption	320 mW +20 % -10 %
Max. switch-on current	120 mA
Combination foot for drop current	≤ 3 mA
Connection	- NO and NC
	- changeover contacts

Rated data der Contacts

Max. output voltage	250 V
Continuous current	5 A
Max. switch-on current	8 A
Min. switching capacity/switching current	100 mW/10 mA
Bounce times	≤ 1 ms
Contact material ²⁾	AgNi 0.15 gold-flashed
Bounce times	≤ 1 ms
Switching times	
pick up delay	≤ 8 ms
drop-out delay	≤ 6 ms
Service life, mechanical	> 15 x 10 ⁶ switching operations
- , 24 V-, 1.1 A, inductive load	≥ 2 x 10 ⁶ switching operations with free wheel diode
- , 230 V-, 5 A, resistive load	> 2 x 10 ⁵ switching operations
Status indicator	Green LED
Storage temperature	-40 °C...+60 °C
Ambient temperature	-25 °C...+60 °C

Insulation coordination acc. to EN 50178

Safe isolation according to VDE 0106 part 101	DIN VDE 0106
Rated impulse voltage	8 kV
Clearances and creepage distances	≥ 8 mm
Overtension category	III
Pollution severity	2

Accessories

Cross-connection comb. 16fold	QB 16/10.16	1650330000
Accessories, dimensions and connection data see	Page 304	

1) Serves only as a spare part for NO and NC

Type	Cat. No.
EGR EG7	8092310000
EGR EG7	8092320000
EGR EG7	8092330000¹⁾
RST EG7	8216550000
RS EG7	8193830000

12 V0 +15 % -10 %
280 mW +20 % -10 %
12 mA
≤ 3 mA
Screw connection
0.5...1.5 mm ²
AWG-Conductor 26...16
0.5...2.5 mm ²

Type	Cat. No.
EGR EG7	8216520000
EGR EG7	8216530000
EGR EG7	8218200000¹⁾
RST EG7	8216570000
RS EG7	8193830000

24 V- +15 % -10 %
280 mW +20 % -10 %
12 mA
≤ 3 mA
Screw connection
0.5...1.5 mm ²
AWG-Conductor 26...16
0.5...2.5 mm ²

Type	Cat. No.
EGR EG7	8147120000
EGR EG7	8147140000
EGR EG7	8160030000¹⁾
RST EG7	8216560000
RS EG7	8193830000

24 V- +15 % -10 %
280 mW +20 % -10 %
12 mA
≤ 3 mA
Screw connection
0.5...1.5 mm ²
AWG-Conductor 26...16
0.5...2.5 mm ²

Type	Cat. No.
EGR EG7	8092340000
EGR EG7	8092350000
EGR EG7	8092360000¹⁾
RST EG7	8216580000
RS EG7	8193830000

24 V0 +15 % -10 %
280 mW +20 % -10 %
12 mA
≤ 3 mA
Screw connection
0.5...1.5 mm ²
AWG-Conductor 26...16
0.5...2.5 mm ²

250 V
5 A
8 A
40 μW ²⁾
≤ 1 ms
AgNi 0.15 5 μ Au
≤ 1 ms

250 V
5 A
8 A
100 mW/10 mA
≤ 1 ms
AgNi 0.15 gold-flashed
≤ 2.4 ms

≤ 8 ms
≤ 6 ms
> 15 x 10 ⁶ switching operations
≥ 2 x 10 ⁶ switching operations with free wheel diode
> 2 x 10 ⁵ switching operations
Green LED
-40 °C...+60 °C
-25 °C...+60 °C

≤ 11 ms
≤ 10 ms
> 15 x 10 ⁶ switching operations
≥ 2 x 10 ⁶ switching operations with free wheel diode
> 2 x 10 ⁵ switching operations
Green LED
-40 °C...+60 °C
-25 °C...+60 °C

DIN VDE 0106
8 kV
≥ 8 mm
III
2

DIN VDE 0106
8 kV
≥ 8 mm
III
2

QB 16/10.16	1650330000
Page 304	

QB 16/10.16	1650330000
Page 304	

²⁾ The following ratings can safely be switched:
a) 100 mV...60 V ac/dc/100 μA...300 mA

b) 5 V... 24 V dc/10 mA... 1.2 A
c) 24 V ... 60 V dc/10 mA... 500 mA
d) 10 V...250 V ac/10 mA... 5 A

After switching higher powers (b...d) lower powers (a) can no longer be switched.

Relay Couplers in Components Housings EG 7

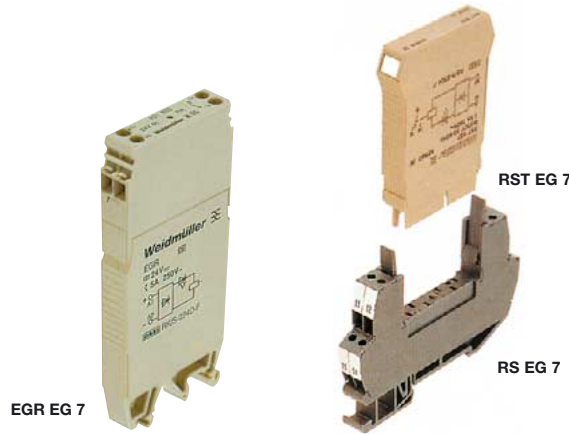

48 V0 60 V~ 115 V0 230 V~ 230 V~

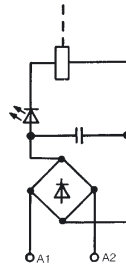
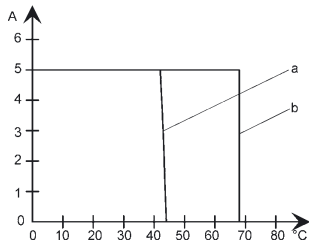

Type	Cat. No.	Type	Cat. No.	Type	Cat. No.	Type	Cat. No.	Type	Cat. No.
EGR EG7	8092370000	EGR EG7	8092400000	EGR EG7	8092430000	EGR EG7	8092460000	EGR EG7	8178200000
EGR EG7	8092380000	EGR EG7	8092410000	EGR EG7	8092440000	EGR EG7	8092470000		
EGR EG7	8092390000¹⁾	EGR EG7	8092420000¹⁾	EGR EG7	8092450000¹⁾	EGR EG7	8092480000¹⁾		
RST EG7	8216590000	RST EG7	8216600000	RST EG7	8216610000	RST EG7	8216620000	RST EG7	8216630000
RS EG7	8193830000	RS EG7	8193830000	RS EG7	8193830000	RS EG7	8193830000	RS EG7	8193830000
48 V0 +15 % -10 %		60 V0 +15 % -10 %		115 V0 +15 % -10 %		230 V~ +15 % -10 %		230 V~ +15 % -10 %	
280 mW +15 % -10 %		280 mW +15 % -10 %		330 mW +15 % -10 %		280 mW +15 % -10 %		280 mW +15 % -10 %	
480 mA		600 mA		160 mA		185 mA		185 mA	
≤ 3 mA		≤ 3 mA		≤ 3 mA		≤ 3 mA		≤ 3 mA	
Screw connection		Screw connection		Screw connection		Screw connection		Screw connection	
0.5...1.5 mm ²		0.5...1.5 mm ²		0.5...1.5 mm ²		0.5...1.5 mm ²		0.5...1.5 mm ²	
AWG-Conductor 26...16		AWG-Conductor 26...16		AWG-Conductor 26...16		AWG-Conductor 26...16		AWG-Conductor 26...16	
0.5...2.5 mm ²		0.5...2.5 mm ²		0.5...2.5 mm ²		0.5...2.5 mm ²		0.5...2.5 mm ²	
250 V		250 V		250 V		250 V		250 V	
5 A		5 A		5 A		5 A		5 A	
8 A		8 A		8 A		8 A		8 A	
100 mW/10 mA		100 mW/10 mA		100 mW/10 mA		100 mW/10 mA		40 μW ²⁾	
≤ 1 ms		≤ 1 ms		≤ 1 ms		≤ 1 ms		≤ 1 ms	
AgNi 0.15 gold-flashed		AgNi 0.15 gold-flashed		AgNi 0.15 gold-flashed		AgNi 0.15 gold-flashed		AgNi 0.15 5 μ Au	
≤ 2.5 ms		≤ 3.8 ms		≤ 3.8 ms		≤ 2 ms		≤ 2 ms	
≤ 12 ms		≤ 12 ms		≤ 12 ms		≤ 12 ms		≤ 12 ms	
≤ 10 ms		≤ 10 ms		≤ 10 ms		≤ 10 ms		≤ 10 ms	
> 15 x 10 ⁶ switching operations		> 15 x 10 ⁶ switching operations		> 15 x 10 ⁶ switching operations		> 15 x 10 ⁶ switching operations		> 15 x 10 ⁶ switching operations	
≥ 2 x 10 ⁶ switching operations		≥ 2 x 10 ⁶ switching operations		≥ 2 x 10 ⁶ switching operations		≥ 2 x 10 ⁶ switching operations		≥ 2 x 10 ⁶ switching operations	
with free wheel diode		with free wheel diode		with free wheel diode		with free wheel diode		with free wheel diode	
> 2 x 10 ⁵ switching operations		> 2 x 10 ⁵ switching operations		> 2 x 10 ⁵ switching operations		> 2 x 10 ⁵ switching operations		> 2 x 10 ⁵ switching operations	
Green LED		Green LED		Green LED		Green LED		Green LED	
-40 °C...+60 °C		-40 °C...+60 °C		-40 °C...+60 °C		-40 °C...+60 °C		-40 °C...+60 °C	
-25 °C...+60 °C		-25 °C...+60 °C		-25 °C...+60 °C		-25 °C...+60 °C		-25 °C...+60 °C	
DIN VDE 0106									
8 kV		8 kV		8 kV		8 kV		8 kV	
≥ 8 mm		≥ 8 mm		≥ 8 mm		≥ 8 mm		≥ 8 mm	
III		III		III		III		III	
2		2		2		2		2	
QB 16/10.16 1650330000		QB 16/10.16 1650330000		QB 16/10.16 1650330000		QB 16/10.16 1650330000		QB 16/10.16 1650330000	
Page 304		Page 304		Page 304		Page 304		Page 304	

PLUGSERIES Relays on Sockets



PRZ/PRS



PRZ/PRS



PRS/PRZ xxx 1CO PRS/PRZ xxx 2CO

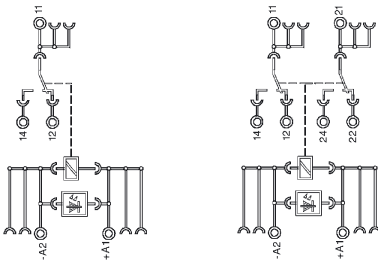

- Modular system comprising:
 - Relay socket for mounting rails
 - LED indicator unit / RC combination
 - retainer clip
 - pluggable relays
- Independent connection technology: screw or tension clamp technology
- Compatible with low power relays type RT / Standard with 1 or 2 CO contacts
- Coil and root-contacts cross-connectable with cross-connection type ZQV 2.5 N
- Available as complete module or as spare parts

DC-Version

Type/Version	Cat. No.	Qty.
Screw connection		
PRS 12Vdc LD 1CO	8536471001	10
PRS 12Vdc LD 2CO	8536501001	10
PRS 24Vdc LD 1CO	8530621001	10
PRS 24Vdc LD 2CO	8530631001	10
PRS 115Vdc LD 1CO	8536510000	10
PRS 115Vdc LD 2CO	8536520000	10
PRS 24Vdc LD 2CO SGR 282	8596000000	10
with gold-plated relay contacts:		
PRS 24Vdc LD 2CO AU	8561760000	10

Tension clamp connection

PRZ 12Vdc LD 1CO	8536571001	10
PRZ 12Vdc LD 2CO	8536591001	10
PRZ 24Vdc LD 1CO	8530691001	10
PRZ 24Vdc LD 2CO	8530701001	10
PRZ 115Vdc LD 1CO	8536610000	10
PRZ 115Vdc LD 2CO	8536630000	10
PRZ 24Vdc LD 2CO SGR 282	8595970000	10
with gold-plated relay contacts:		
PRZ 24Vdc LD 2CO AU	8552440000	10

Other variants on request

Technical data

Input voltage	12 V dc ... 24Vdc ... 115Vdc
Rated consumption, typ	400 mW
Status indicator	pluggable LED-housing, green LED

Output

Contact version	1 x UM / 2 x UM
Max. output voltage	250Vuc
Max. switching current	16A / 2 x 8A
Continuous current	10A
Rated braking capacity	4kVA / 2 x 2kVA
Service life, mech.	30 x 10 ⁶

Input/output

Clearance and creepage path	> 8mm
Protective separation	DIN VDE 0106 T. 101
Dielectric strength	> 4kV eff
Insulation coordinates acc. to EN 50178	III / 2

Miscellaneous data

Ambient temperature	-40°C ... +50°C
Protection class	IP 20
Rated cross-section	0.5...2.5mm ²
Flammability	V0
Relay type	Schrack RT1 / RT2
Dimensions WxHxT	15.2 x 91 x 85
Approvals	CE, UL recognized, cUL
Rail mounted	TS 35

Accessories

Cross-connection	
2-pole black	ZQV 2.5N/4-2 SW 1784270000 60
2-pole red	ZQV 2.5N/4-2 RT 1784280000 60
2-pole blue	ZQV 2.5N/4-2 BL 1784290000 60

Marking tags

WS 10/5	1060860000
WS 15/5	1609880000

AC-Version

Type/Version	Cat. No.	Qty.
Screw connection		
PRS 24Vac LD 1CO	8536530000	10
PRS 24Vac LD 2CO	8536560000	10
PRS 120Vac LD 1CO	8530641001	10
PRS 120Vac LD 2CO	8530661001	10
PRS 230Vac LD 1CO	8530671001	10
PRS 230Vac LD 2CO	8530681001	10
with gold-plated relay contacts:		
PRS 120Vac LD 2CO AU	8595960000	10
PRS 230Vac LD 2CO AU	8595990000	10

Tension clamp connection

PRZ 24Vac LD 1CO	8536651001	10
PRZ 24Vac LD 2CO	8536681001	10
PRZ 120Vac LD 1CO	8530710001	10
PRZ 120Vac LD 2CO	8530720001	10
PRZ 230Vac LD 1CO	8530731001	10
PRZ 230Vac LD 2CO	8530741001	10
with gold-plated relay contacts:		
PRZ 120Vac LD 2CO AU	8575940000	10
PRZ 230Vac LD 2CO AU	8575950000	10

Other variants on request

Technical data

Input voltage	24Vac ... 120Vac ... 230Vac
Rated consumption, typ	760 VA
Status indicator	pluggable LED-housing, green LED

Output

Contact version	1 x UM / 2 x UM
Max. output voltage	250Vuc
Max. switching current	16A / 2 x 8A
Continuous current	10A
Rated braking capacity	4kVA / 2 x 2kVA
Service life, mech.	5 x 10 ⁶

Input/output

Clearance and creepage path	> 8mm
Protective separation	DIN VDE 0106 T. 101
Dielectric strength	> 4kV eff
Insulation coordinates acc. to EN 50178	III / 2

Miscellaneous data

Ambient temperature	-40°C ... +50°C
Protection class	IP 20
Rated cross-section 0.5 mm ²	0.5...2.5mm ²
Flammability	V0
Relay type	Schrack RT1 / RT2
Dimensions WxHxT	15.2 x 91 x 85
Approvals	CE, UL recognized, cUL
Rail mounted	TS 35

Accessories

Cross-connection	
2-pole black	ZQV 2.5N/4-2 SW 1784270000 60
2-pole red	ZQV 2.5N/4-2 RT 1784280000 60
2-pole blue	ZQV 2.5N/4-2 BL 1784290000 60

Marking tags

WS 10/5	1060860000
WS 15/5	1609880000

PLUGSERIES Relays on Sockets

Accessories

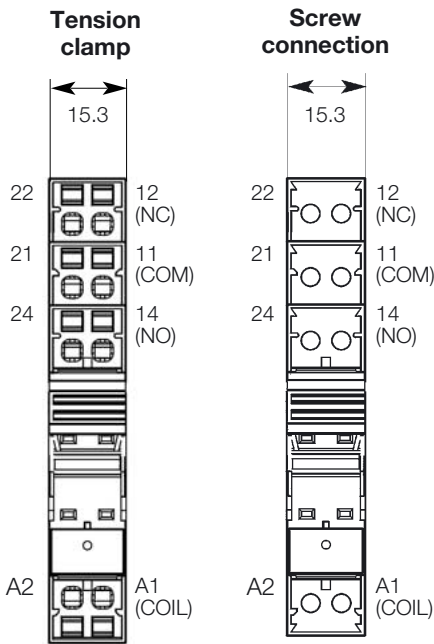
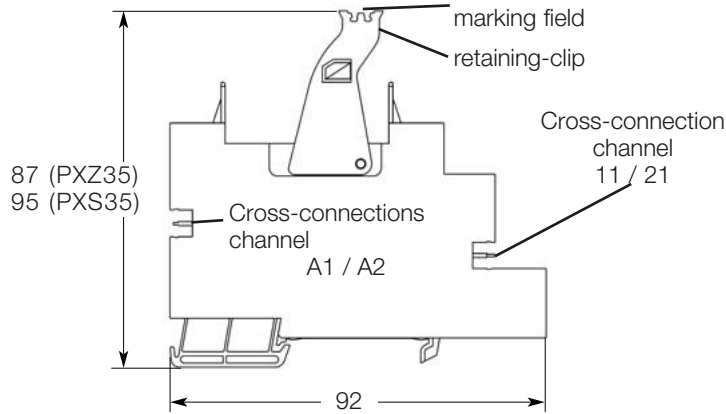

Empty base for rail mounted TS 35

Screw connection	PXS35	10
Tension clamp connection	PXZ35	10

Type	Cat. No.	Qty.
PXS35	8533771001	10
PXZ35	8536691001	10

Technical data

Rated current	16 A
Rated voltage	250 V
Dielectric strength coil/contacts	> 4 kV
Protection class	IP 20
Rated cross-section	2.5 mm ²
Insulation stripping length	
- Screw connection	8 mm
- Tension clamp connection	10 mm
Ambient temperature	-40°C ... +60°C
Flammability class UL 94	V0

Holding clamp

PRC	8536700000	100
-----	------------	-----

Operating indication

LED indicator with free-wheeling diode

Operating voltage	Operating voltage	Cat. No.	Qty.
6 ... 24 Vdc	PLED 24 Vdc	8536710000	20
6 ... 24 Vdc	PLED 24 Vdc red	8611010000	20
48 ... 60 Vdc	PLED 48 Vdc	8536720000	20
115 Vdc	PLED 115 Vdc	8536730000	20
12 ... 24 Vac	PLED 24 Vac	8536750000	20
115 Vac	PLED 120 Vac	8536760000	20
230 Vac	PLED 230 Vac	8536780000	20
230 Vac	PLED 230 Vac red	8611000000	20
RC combination 120...230 VAC/DC	PLRC 200 nF/200Ω	8566530000	20

Operating indication

DC-Version

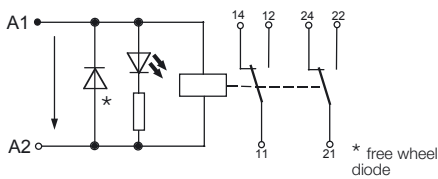

AC-Version

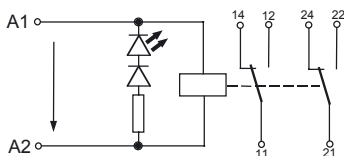

Pluggable cross-connections

2-pole black	ZQV 2.5N/4-2SW	1784270000	60
2-pole red	ZQV 2.5N/4-2RT	1784280000	60
2-pole blue	ZQV 2.5N/4-2BL	1784290000	60

Marking tags

10 x 5 mm	Type	Cat. No.	Qty.
	WS 10/5	1060860000	200
	WS 15/5	1609880000	96

PLUGSERIES Relays on Sockets

Pluggable relay types

Print figure/circuit diagram Relay type RT/SGR

16 A, Pinning 5 mm

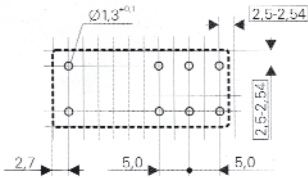

1 changeover contact

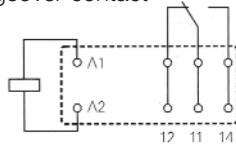

2 changeover contacts

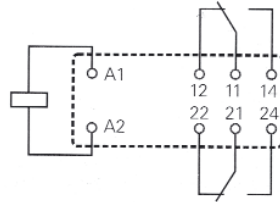

SCHRACK RT

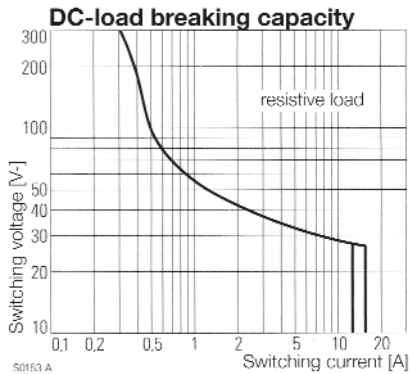
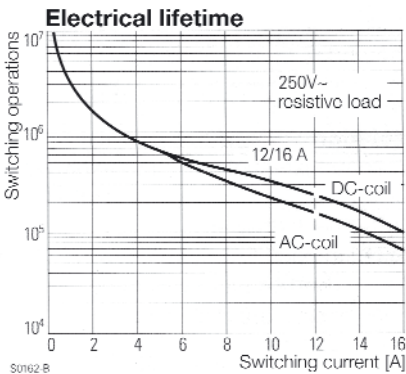

Pluggable relay

12 Vdc 1 changeover contact
12 Vdc 2 changeover contacts
24 Vdc 1 changeover contact
24 Vdc 1 changeover contact AU
24 Vdc 2 changeover contacts
24 Vdc 2 changeover contacts AU
48 Vdc 1 changeover contact
48 Vdc 2 changeover contacts
60 Vdc 2 changeover contacts
110 Vdc 1 changeover contact
110 Vdc 2 changeover contacts
24 Vac 1 changeover contact
24 Vac 2 changeover contacts
115 Vac 1 changeover contact
115 Vac 1 changeover contact AU
115 Vac 2 changeover contacts
115 Vac 2 changeover contacts AU
230 Vac 1 changeover contact
230 Vac 1 changeover contact AU
230 Vac 2 changeover contacts
230 Vac 2 changeover contacts AU

Type Schrack RT	Cat. No.	Qty.
RT 314012	4058470000	20
RT 424012	4058560000	20
RT 314024	4058480000	20
RT 315024	4058490000	20
RT 424024	4058570000	20
RT 425024	4058580000	20
RT 314048	4058740000	20
RT 424048	4058750000	20
RT 424060	4058760000	20
RT 314110	4058500000	20
RT 424110	4058590000	20
RT 315524	4058510000	20
RT 424524	4058600000	20
RT 314615	4058520000	20
RT 315625	4058530000	20
RT 424615	4058610000	20
RT 425615	4058620000	20
RT 314730	4058540000	20
RT 315730	4058550000	20
RT 424730	4058630000	20
RT 425730	4058640000	20

Technical data

Contact number and type	1 changeover contact or 2 changeover contacts
Contact material	AgNi 90/10, AgNi 0.15 htv
Switching current	16 A 1We/2 x 8 A 2We
Switching voltage	250 V ac
Braking capacity	4 kVA
Min. switching current / braking capacity	10 mA /100 mW
Min. braking capacity AU contact	40 μW
Rated consumption	400 mW dc/0.55 VA ac
Dielectric strength Sp./Kont.	5 kV
Response / drop out time:	DC coil typ. 7/3 ms AC coil 9/45 ms
Bounce time NO contact/normally closed contact	typ. 1/3 ms
Mechanical service life:	DC coil > 30 x 10 ⁶ switching operations AC coil > 30 x 10 ⁶ switching operations
Braking capacity	1-pole DC 13 1.25A, L/R = 80 ms 2.3 x 10 ⁵ 2-pole DC 13 1.25A, L/R = 80 ms 2.8 x 10 ⁵ 2-pole AC 15 1.2A, cosL/R = 0.3 6050x

Miscellaneous data

Protection class	IP 40
Flammability class UL	V0
Ambient temperature	DC coil -40°C ... +85°C AC coil -40°C ... +70°C
Weight	14 g
Approvals	UL, CSA, VDE, ÖVE

PLUGSERIES Relays on Sockets

ELESTA SGR Relais with manual operation



RP 3SL Relays for high switching currents



Pluggable relay	
24 Vdc 1 changeover contact with test button	
24 Vdc 2 changeover contacts with test button	
24 Vdc 1 normally-open contact	
Technical data	
Contact number and type	2 changeover contacts with test button
Contact material	AgCuNi
Switching current	16 A 1We/2 x 8 A 2We
Peak inrush current	
Switching voltage	250 Vac
Braking capacity	4 kVA
Min. switching current / braking capacity	10 mA / 100 mW
Rated consumption	500 mW
Dielectric strength Sp./Kont.	5 kV
Response / drop out time:	DC coil typ. 10/3 ms
Bounce time NO contact/normally closed contact	typ. 0.5/5 ms
Mechanical service life:	DC coil > 30 x 10 ⁶ switching operations
Miscellaneous data	
Protection class	IP 40
Flammability class UL	V1
Ambient temperature	DC coil -25°C ... +70°C
Weight	20 g
Approvals	SEV, UL, CSA, DEMKO, VDE, PTB

Type	ELESTA SGR	Cat. No.	Qty.
	SGR 662 24 Vdc T	8550510000	10
	SGR 282 24 Vdc T	8550520000	10

Type	Schrack RP 3SL	Cat. No.	Qty.
	RP3SL 24 Vdc 1NO	8588510000	20
	1 normally-open contact		
	AgSnO ₂		
	25 A		
	120 A / 20 ms		
	250 V		
	4 kVA		
	500 mW		
	4 kV		
	typ. 8/2 ms		
	typ. 2 ms		
	30 x 10 ⁶ switching operations		
	IP 40		
	-40°C ... +70°C		
	18 g		
	SEV, UL, CSA, VDE		

Contact service life			
Type	Load	switch. oper.	Regulation
RP3SL	12 A, 250 V~, cosφ=1	3x10 ⁵	
RP3SL	TV 8	25x10 ³	UL 508
RP3SL	2500 W, 230 V~, halogene lamps	>10 ⁴	
RP3SL	1000 W, 250 V~, glow lamps	2.3x10 ⁵	
RP3SL	3000 W, 250 V~, glow lamps	3.6x10 ⁴	
RP3SL	1500 VA, fluorescent tubes 163 µF	10 ⁴	

Leistungsrelais Type RT2 2 changeover contacts

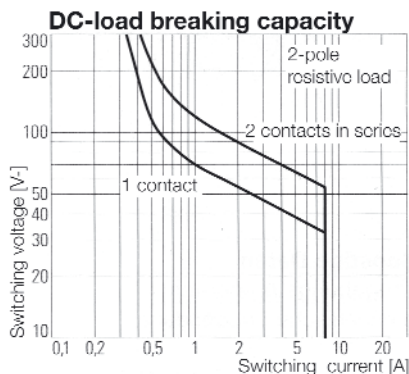
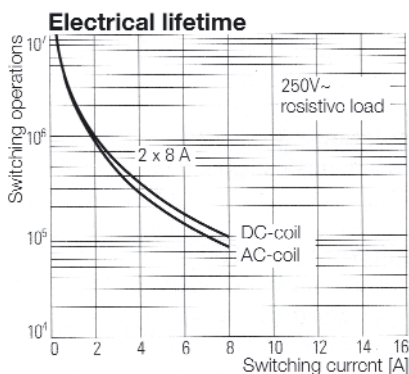

Power relay RP 3SL

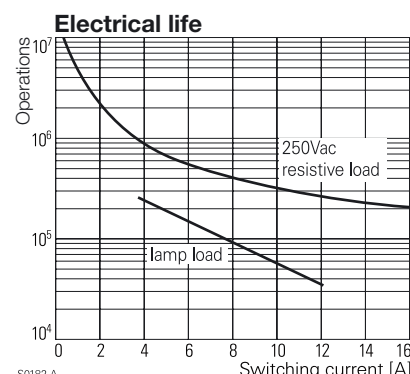

Relay Couplers on Sockets MICROSERIES in Terminal Format

MICRORELAY MRS/MRZ

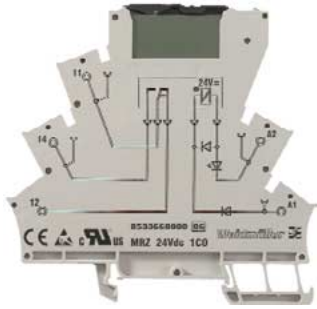

MRS 5 Vdc 1CO
MRZ 5 Vdc 1CO

MRS 12 Vdc 1CO
MRZ 12 Vdc 1CO



This module can be used as a universal interface between the controller and actuator for switching small to medium-sized loads.

- Pluggable cross-connection in the input and output reduces wiring costs
- 6-mm width
- Flexible thanks to screw and tension clamp connection versions

Schematic circuit diagram

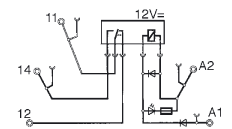
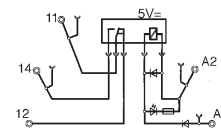

Limit diagram

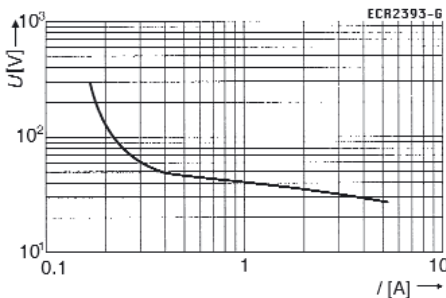

Current temperature-rise curve

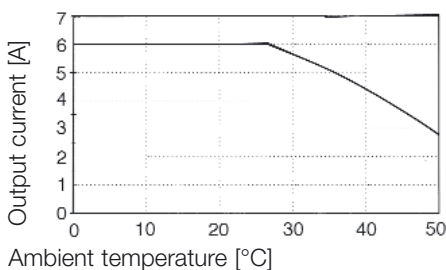

Ordering data

for TS 35
Screw connection
Tension clamp connection

Type	Cat. No.
MRS 5 Vdc 1CO	8556080000
MRZ 5 Vdc 1CO	8556150000

Type	Cat. No.
MRS 12 Vdc 1CO	8556070000
MRZ 12 Vdc 1CO	8556140000

Technical data

Input

Input voltage
Input voltage ac with U_{Nenn}
Input voltage dc with U_{Nenn}
Input power
Making threshold, (typ.)
Cut-out threshold (typ.)
Status indicator
Reaction time at U_N (typ.)
Release at U_N (typ.)
Voltage of relay coil

5 Vdc $\pm 20\%$ (4...6 V)

38.5 mAdc $\pm 10\%$
193 mW $\pm 10\%$
3.2 V / 21.6 mA
1.6 V / 8 mA
Green LED
6.2 ms
3.9 ms
5 V

12 Vdc $\pm 20\%$ (9.6...14.4 V)

17.2 mAdc $\pm 10\%$
210 mW $\pm 10\%$
6.4 V / 8.4 mA
2.5 V / 2.4 mA
Green LED
5.8 ms
6.9 ms
12 V

Functionality

Operating indication
Reverse polarity protection
Free wheel diode

yes
yes
yes

yes
yes
yes

Output

Switching voltage

ac: continuous current/switching power (see derating diagram)
Switch-on current
dc: Continuous current/switching power
Min. braking capacity
Contact material
Mechanical service life
Max. switching frequency at nominal voltage

1 changeover contact
250 Vac acc. to VDE
240 Vac acc. to UL/CSA
max. 6 A / max. 1500 VA
max. 6 A
see limit diagram
12 V / 10 mA
AgSnO
20 x 10⁶ switching operations
0.1 Hz

1 changeover contact
250 Vac acc. to VDE
240 Vac acc. to UL/CSA
max. 6 A / max. 1500 VA
max. 6 A
see limit diagram
12 V / 10 mA
AgSnO
20 x 10⁶ switching operations
0.1 Hz

Ambient temperature
Storage temperature
Climate

-25 °C...+50 °C
-40 °C...+60 °C
40 °C / 93 % rel. humidity,
no condensation

-25 °C...+50 °C
-40 °C...+60 °C
40 °C / 93 % rel. humidity,
no condensation

Approvals

CE, cUL

CE, cUL

Insulation coordination acc. to EN 50178

Rated voltage
Rated impulse voltage
Overvoltage category
Pollution severity
Insulation coord.- and voltage proof, input/output mounting rail
Achieved clearances and creepage distances

300 V
4 kV (1.2 / 50 μ s)
III
2
4 kV_{eff} / 1 min
 ≥ 5.5 mm

300 V
4 kV
III
2
4 kV_{eff} / 1 min
 ≥ 5.5 mm

Relay Couplers on Sockets MICROSERIES in Terminal Format

MRS 24 Vdc 1CO

MRS 24 Vuc 1CO

MRS 48 Vuc 1CO

MRS 60 Vdc 1CO

MRS 120 Vuc 1CO

MRS 230 Vac 1CO

MRZ 24 Vdc 1CO

MRZ 24 Vuc 1CO

MRZ 48 Vuc 1CO

MRZ 60 Vdc 1CO

MRZ 120 Vuc 1CO

MRZ 230 Vac 1CO

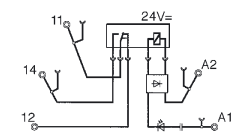
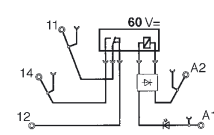
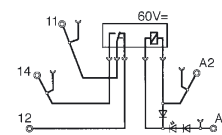
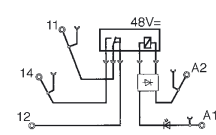
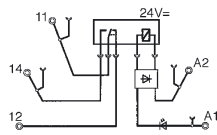
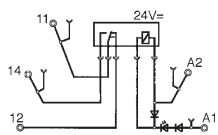

Type	Cat. No.	Type	Cat. No.	Type	Cat. No.	Type	Cat. No.	Type	Cat. No.	Type	Cat. No.
MRS 24 Vdc 1CO	8533640000	MRS 24 Vuc 1CO	8556050000	MRS 48 Vuc 1CO	8556040000	MRS 60 Vdc 1CO	8556060000	MRS 120 Vuc 1CO	8556030000	MRS 230 Vac 1CO	8556020000
MRZ 24 Vdc 1CO	8533660000	MRZ 24 Vuc 1CO	8556120000	MRZ 48 Vuc 1CO	8556110000	MRZ 60 Vdc 1CO	8556130000	MRZ 120 Vuc 1CO	8556100000	MRZ 230 Vac 1CO	8556090000
24 Vdc ± 20 % (19.2...28.8 V)		24 Vuc ±10% (21.6...26.4 V)		48 Vuc ±10% (43.2...52.8 V)		60 Vdc ±20% (48...72 V)		120 Vuc +10%/-15% (102...132 V)		230 Vac ±10% (207...253 V)	
6.6 mAdc ±10 %		11 mA ±10 %		5 mA ±20 %		3.3 mAdc ±20 %		3.5 mAac ±15 %		7.6 mA ±15%	
160 mW ±10%		6.4 mA ±20 %		4 mA ±20 %		200 mW ±10 %		0.42 VA ±15 %		1.55 VA ±15 %	
15.4 V / 4 mA		154 mW ±10 %		190 mW ±20 %		35 V / 1.6 mA		71 V / 1.8 mA		103 V / 5 mA	
6.5 V / 1.2 mA		15.8 V / 3.6 mA		29 V / 2.2 mA		11 V / 0.6 mA		22 V / 0.5 mA		49 V / 2.5 mA	
Green LED		7 V / 1.3 mA		11 V / 1.3 mA		Green LED		Green LED		Green LED	
6.6 ms		Green LED		Green LED		5.9 ms		6.7 ms		13 ms	
5.8 ms		7.3 ms		6.1 ms		6.5 ms		8.1 ms		11 ms	
24 V		9 ms		5.8 ms		60 V		60 V		24 V	
		24 V		48 V							
yes		yes		yes		yes		yes		yes	
yes		yes		yes		yes		yes		-	
yes		yes		yes		yes		yes		-	
1 changeover contact		1 changeover contact		1 changeover contact		1 changeover contact		1 changeover contact		1 changeover contact	
250 Vac acc. to VDE		250 V ~ acc. to VDE		250 Vac acc. to VDE		250 Vac acc. to VDE		250 V ~ acc. to VDE		250 V ~ acc. to VDE	
240 Vac acc. to UL/CSA		240 V ~ acc. to UL/CSA		240 Vac acc. to UL/CSA		240 Vac acc. to UL/CSA		240 V ~ acc. to UL/CSA		240 V ~ acc. to UL/CSA	
max. 6 A / max. 1500 VA		max. 6 A / max. 1500 VA		max. 6 A / max. 1500 VA		max. 6 A / max. 1500 VA		max. 6 A / max. 1500 VA		max. 6 A / max. 1500 VA	
max. 6 A		max. 6 A		max. 6 A		max. 6 A		max. 6 A		max. 6 A	
see limit diagram		see limit diagram		see limit diagram		see limit diagram		see limit diagram		see limit diagram	
12 V /10 mA		12 V /10 mA		12 V /10 mA		12 V /10 mA		12 V /10 mA		12 V /10 mA	
AgSnO		AgSnO		AgSnO		AgSnO		AgSnO		AgSnO	
20 x 10 ⁶ switching operations		20 x 10 ⁶ switching operations		20 x 10 ⁶ switching operations		20 x 10 ⁶ switching operations		20 x 10 ⁶ switching operations		20 x 10 ⁶ switching operations	
0.1 Hz		0.1 Hz		0.1 Hz		0.1 Hz		0.1 Hz		0.1 Hz	
-25 °C...+50 °C		-25 °C...+50 °C		-25 °C...+50 °C		-25 °C...+50 °C		-25 °C...+50 °C		-25 °C...+50 °C	
-40 °C...+60 °C		-40 °C...+60 °C		-40 °C...+60 °C		-40 °C...+60 °C		-40 °C...+60 °C		-40 °C...+60 °C	
40 °C / 93 % rel. humidity, no condensation		40 °C / 93 % rel. humidity, no condensation		40 °C / 93 % rel. humidity, no condensation		40 °C / 93 % rel. humidity, no condensation		40 °C / 93 % rel. humidity, no condensation		40 °C / 93 % rel. humidity, no condensation	
CE, cUL		CE, cUL		CE, cUL		CE, cUL		CE, cUL		CE, cUL	
300 V		300 V		300 V		300 V		300 V		300 V	
4 kV		4 kV		4 kV		4 kV		4 kV		4 kV	
III		III		III		III		III		III	
2		2		2		2		2		2	
4 kV _{eff} / 1 min		4 kV _{eff} / 1 min		4 kV _{eff} / 1 min		4 kV _{eff} / 1 min		4 kV _{eff} / 1 min		4 kV _{eff} / 1 min	
≥ 5.5 mm		≥ 5.5 mm		≥ 5.5 mm		≥ 5.5 mm		≥ 5.5 mm		≥ 5.5 mm	

Relay Couplers on Sockets MICROSERIES in Terminal Format

Accessories

Tension clamp version MRZ

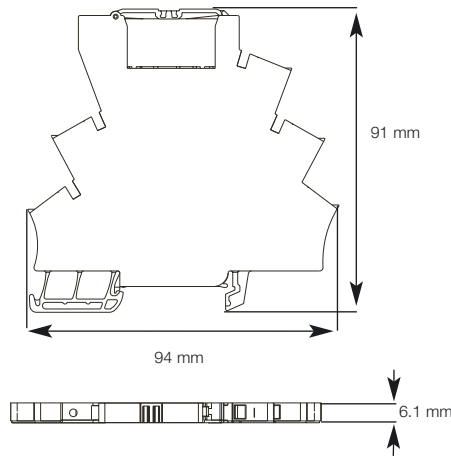

Screw version MRS

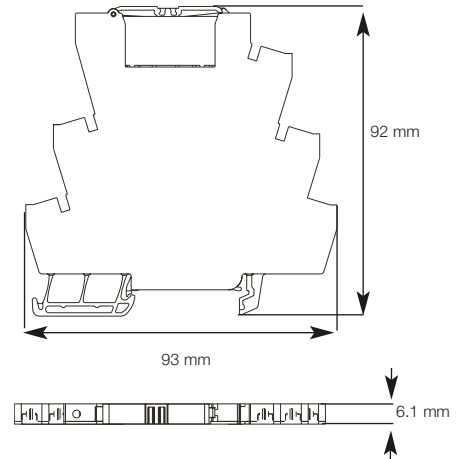

General technical data		Tension clamp version			Screw version		
Clampable conductor:							
Solid H07V-U	mm ²	0.5...2.5			0.5...4		
Fsolid H07V-K	mm ²	0.5...2.5			0.5...2.5		
„f“ with ferrules acc. to DIN 46 228/1*	mm ²	0.5...1.5			0.5...1.5		
„f“ with ferrules with plastic collar*	mm ²	0.5...1.5			0.5...1.5		
Max. clampable range in mm ² /gauge pin acc. to IEC 60 947-1 Size		0.13...2.5 A 2			0.13...4 A 3		
Rated torque		-			0.6 Nm		
Continuous current of cross-connection 2-pole	A	10			10		
Continuous current of cross-connection multipole	A	10			10		
Insulation stripping length	mm	10			7		
Protection class		IP 20			IP 20		
Housing material		Wemid			Wemid		
Flammability class UL 94		V0			V0		
Rated current		6 A			6 A		
Rated voltage		250 V			250 V		
Cross-connection		Type	Cat. No.	Qty.	Type	Cat. No.	Qty.
Pluggable cross-connection							
ZQV	yellow	ZQV 4N / 2 GE	1758250000	60	ZQV 4N / 2 GE	1758250000	60
		ZQV 4N / 3 GE	1762630000	60	ZQV 4N / 3 GE	1762630000	60
		ZQV 4N / 4 GE	1762620000	60	ZQV 4N / 4 GE	1762620000	60
		ZQV 4N / 10 GE	1758260000	20	ZQV 4N / 10 GE	1758260000	20
		ZQV 4N / 41 GE	1758270000	10	ZQV 4N / 41 GE	1758270000	10
	red	ZQV 4N / 2 RT	1793950000	60	ZQV 4N / 2 RT	1793950000	60
		ZQV 4N / 3 RT	1793980000	60	ZQV 4N / 3 RT	1793980000	60
		ZQV 4N / 4 RT	1794010000	60	ZQV 4N / 4 RT	1794010000	60
		ZQV 4N / 10 RT	1794040000	20	ZQV 4N / 10 RT	1794040000	20
		ZQV 4N / 41 RT	1794070000	10	ZQV 4N / 41 RT	1794070000	10
	blue	ZQV 4N / 2 BL	1793960000	60	ZQV 4N / 2 BL	1793960000	60
		ZQV 4N / 3 BL	1793990000	60	ZQV 4N / 3 BL	1793990000	60
		ZQV 4N / 4 BL	1794020000	60	ZQV 4N / 4 BL	1794020000	60
		ZQV 4N / 10 BL	1794050000	20	ZQV 4N / 10 BL	1794050000	20
		ZQV 4N / 41 BL	1794080000	10	ZQV 4N / 41 BL	1794080000	10
	black	ZQV 4N / 2 SW	1793970000	60	ZQV 4N / 2 SW	1793970000	60
		ZQV 4N / 3 SW	1794000000	60	ZQV 4N / 3 SW	1794000000	60
		ZQV 4N / 4 SW	1794030000	60	ZQV 4N / 4 SW	1794030000	60
		ZQV 4N / 10 SW	1794060000	20	ZQV 4N / 10 SW	1794060000	20
		ZQV 4N / 41 SW	1794090000	10	ZQV 4N / 41 SW	1794090000	10
Markings		Type	Cat. No.	Qty.	Type	Cat. No.	Qty.
12 x 6 mm		WS 10/6	1060960000	200	WS 10/6	1060960000	200
		WS 12/6	1061160000	200	WS 12/6	1061160000	200
Screwdriver		Type	Cat. No.	Qty.	Type	Cat. No.	Qty.
		SD 0.6 x 3.5 x 100	9008330000	10	SD 0.6 x 3.5 x 100	9008330000	10

Relay Couplers on Sockets MICROSERIES in Terminal Format

Accessories

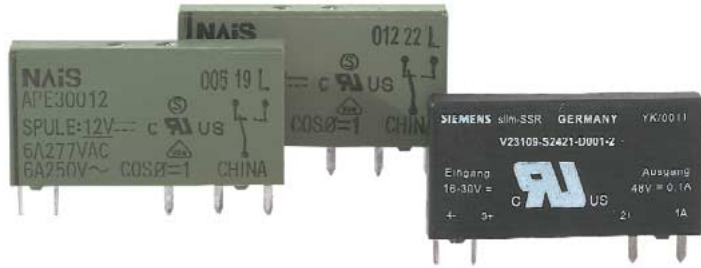

Contact service life Material AgSnO₂

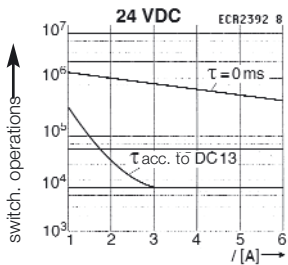
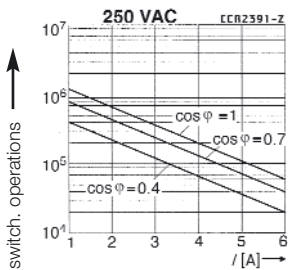

Pluggable relay

Coil voltage 5 V, 1 changeover contact
Coil voltage 12 V, 1 changeover contact
Coil voltage 24 V, 1 changeover contact
Coil voltage 48 V, 1 changeover contact
Coil voltage 60 V, 1 changeover contact
Coil voltage 24 V, 1 changeover contact, 5 μAU
Coil voltage 60 V, 1 changeover contact, 5 μAU

Type NAIS APE...	Cat. No.	Qty.
... 30005V	4061580000	20
... 30012V	4061610000	20
... 30024V	4060120000	20
... 30048V	4061620000	20
... 30060V	4061630000	20
... 30124V	4061590000	20
... 30160V	4061600000	20

Technical data (of relay manufacturer)

Contact number and type
Contact version
Switching current
Switching voltage / max. Switching voltage
Braking capacity
Contact material
Recommended min. load
Typ. bounce time NO contact
Typ. bounce time normally closed contact

1 changeover contact
Single contact
6 A
300 Vdc / 400 Vac
1500 VA
AgSnO ₂
≥ 100 mA, 12 V
1 ms
5 ms

Miscellaneous data

Flammability class UL
Ambient temperature
Max. switching operations with rated load / without load
Response / drop out time
Bounce time NO contact / normally closed contact
Protection class Housing

V-0
-40 ... +85 °C
6/1200 switching operations per minute
5 / 2.5 ms
1.5 / 5 ms
IP 67

For further data see also

www.matsushita.de

Relay Couplers on Sockets RS 30

1 NC, 1 NO
or 1 changeover contact

Schematic circuit diagram

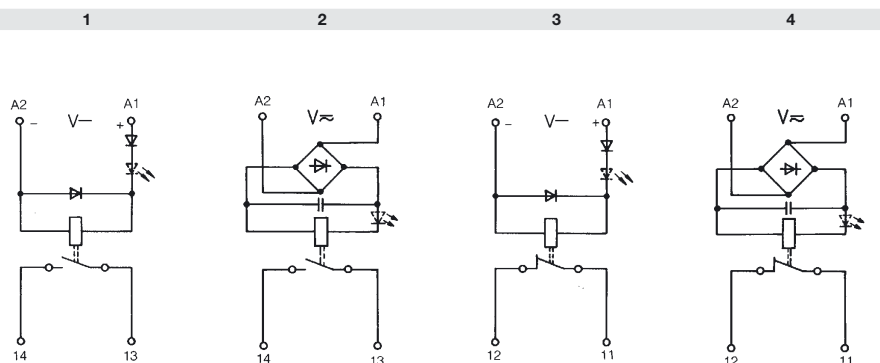

Rated data

Input voltage 5...60 V ± 10%; 115 V/230 V + 5% – 15%

Rated consumption – (W)	0.45 W ¹⁾	0.45 W	0.45 W	0.45 W	0.45 W	0.45 W	–	0.82 W	–	–
Rated consumption ~ (VA)	–	–	–	0.7 VA	–	0.6 VA	–	0.8 VA	–	0.8 VA
Drop-out current of the relay (at 20 °C)	–	3 mA	3 mA	2.5 mA	2 mA	2.5 mA	1 mA	–	2 mA	–
Drop-out current of the relay (at 20 °C)	–	–	–	3.5 mA	–	4.5 mA	–	1 mA	–	1 mA
Pick-up current	–	–	12 mA	–	10 mA	–	–	6 mA	4.3 mA	–
Max. output voltage	250 V	250 V	250 V	250 V	250 V	250 V	250 V	250 V	250 V	250 V
Continuous current	5 A	6 A	6 A	6 A	6 A	5 A	5 A	5 A	5 A	3 A

5 VTTL	12 V~	24 V~	24 V0	48 V~	48 V0	60 V~	115 V~	115 V~	230 V~ ²⁾	240 V~
0.45 W ¹⁾	0.45 W	0.45 W	0.45 W	0.45 W	0.45 W	0.45 W	–	0.82 W	–	–
–	–	–	0.7 VA	–	0.6 VA	–	0.8 VA	–	0.8 VA	1.2 VA
–	3 mA	3 mA	2.5 mA	2 mA	2.5 mA	1 mA	–	2 mA	–	0.5 mA
–	–	–	3.5 mA	–	4.5 mA	–	1 mA	–	1 mA	1 mA
–	–	12 mA	–	10 mA	–	–	6 mA	4.3 mA	–	–
250 V	250 V	250 V	250 V	250 V	250 V	250 V	250 V	250 V	250 V	250 V
5 A	6 A	6 A	6 A	6 A	5 A	5 A	5 A	5 A	3 A	3 A

Derating curve
a = mounted horizontally on rail without clearance
b = mounted horizontally on rail with clearance x 20 mm

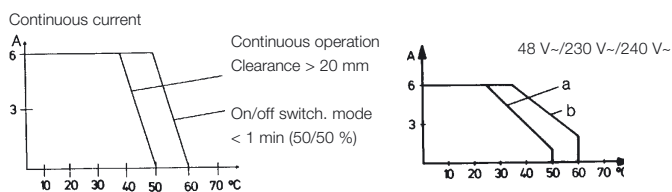
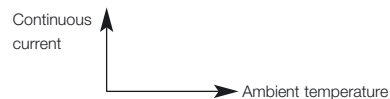

Switch-on current	8 A
Switching capacity with resistive load	2000 VA/100 W
Min. switching capacity/switching current	250 mW/10 mA
Bounce times	≤ 3 ms
Switching times, typical	
–, pick-up lag	≤ 8 ms
–, turn off delay	≤ 7 ms
Max. switching frequency	70 Hz
Contact material	AgNi, gold-flashed
Service life, mechanical	>10 ⁷ switching operations
–, 24 V~, 1 A, resistive load	> 5 x 10 ⁵ switching operations
–, 230 V~, 3 A, resistive load	>7 x 10 ⁵ switching operations
Storage temperature	–40 °C...+60 °C
Ambient temperature	
–, mounted on rail without clearance	–25 °C...+40 °C
–, mounted on rail with clearance ≥ 20 mm	–25 °C...+50 °C

Insulation coordination acc. to EN 50178

Overvoltage category	III
Pollution severity	2
Dimensions	
Mounting width	11.2 mm NO/NC, 25 mm changeover contacts
Length (perpendicular to mounting rail)	70 mm (74 mm BL/SL version)
Height TS 32/TS 35 x 7.5	56 mm/51.5 mm

¹⁾ Rated consumption with 24 VDC auxiliary voltage.

²⁾ 230 V~ on request

Relay Couplers on Sockets RS 30

RS 30

Screw connection
1 NO
1 NC

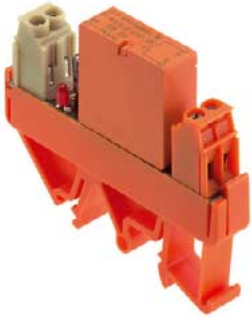

5

RS 30

Screw connection
1 changeover contact



6

RS 30

Disconnect plug with screw connection
1 changeover contact



8

RS 30 TTL

Disconnect plug with screw connection
1 NO and 1 NC

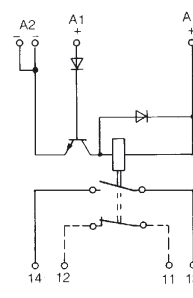
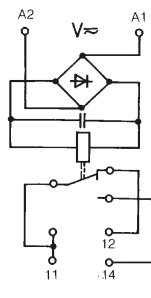
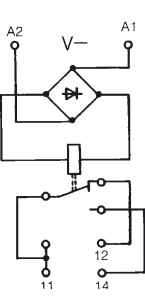
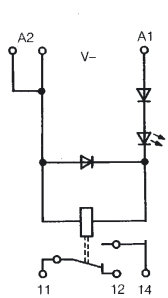
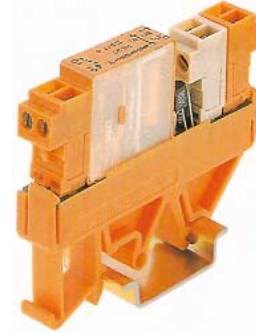

Ordering data

Connection method	Screw connection (LP)					Disconnect plug with screw connection (BL/SL)			
Schematic circuit diagram	1	2	3	4	5	6	7	8	8
Contact	NO	NO	NC	NC	changeo. c.	changeo. c.	changeo. c.	NO	NC

Input voltage	Function indicator									
5 V-, TTL	None						1167760000 1167660000			
12 V-	None						1129660000			
	Red LED	1129421001	1129521001							
	None	1101661001	1100961001			1100260000				
24 V-	Green LED	1101611001	1100911001		1181511001	1100210000				
	Red LED	1101621001	1100921001		1181521001	1100220000				
	None	1101761001		1101061001		1100360000				
24 Vb	Green LED	1101711001		1101011001						
	Red LED	1101721001		1101021001						
	None	1101861001	1101161001			1100460000				
48 V-	Green LED	1101811001	1101111001			1100410000				
	Red LED	1101821001	1101121001			1100420000				
	None	1101961001		1101261001		1100560000				
48 Vb	Green LED	1101911001		1101211001						
	Red LED	1101921001		1101221001						
	None	1102061001					1100660000			
60 V-	Green LED	1102011001					1100610000			
	Red LED	1102021001					1100620000			
	None	1155161001	1155261001							
115 V-	Green LED	1155111001	1155211001							
	Red LED	1155121001	1155221001							
	None	1102161001		1101461001		1100760000				
115 V-	Green LED	1102111001		1101411001						
	Red LED	1102121001		1101421001						
	None	1102261001		1101561001		1100860000				
230 V-	Green LED	1102211001		1101511001						
	Red LED	1102221001		1101521001						
	None	1128561001		1128661001						
240 V-	Green LED	1128511001		1128611001						
	Red LED	1128521001		1128621001						

Relay Couplers on Sockets RS 30

1 changeover contact

- Usable for high switching-power
- Suitable for switching inductive loads

RS 31

with power contacts

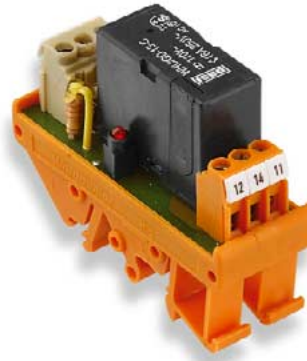

Schematic circuit diagram

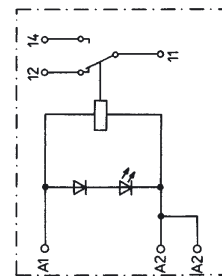
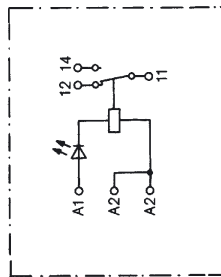

Ordering data	Type	Cat. No.	Type	Cat. No.	Type	Cat. No.	Type	Cat. No.
	RS 31, 24 V-	1128361001	RS 31, 48 V-	1150761001	RS 31, 115 V-	1150361001	RS 31, 115 V~	1150461001
	RS 31, 24 V-	1128331001						
	RS 31, 24 V-	1128311001						

Rated data	Type	Cat. No.	Type	Cat. No.	Type	Cat. No.	Type	Cat. No.
Input voltage	24 V-, ±10 %		48 V-, ±10 %		115 V-, +5 % -15 %		115 V-, +5 % -15 %	
Rated consumption – (W)	1 W		1 W		1 W		–	
Rated consumption – (VA)	–		–		–		1 VA	
Drop-out current of the relay (at 20 °C)	11.5 mA-		13.5 mA-		5.5 mA-		–	
Drop-out current of the relay (at 20 °C)	–		–		–		1.5 mA-	
Max. output voltage	250 V		250 V		250 V		250 V	
Continuous current	16 A		16 A		16 A		16 A	

Derating curve
mounted horizontally on rail without clearance

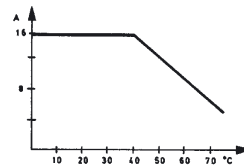
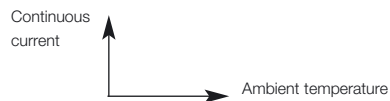

	Type	Cat. No.	Type	Cat. No.	Type	Cat. No.	Type	Cat. No.
Switch-on current	60 A/200 ms		60 A/200 ms		60 A/200 ms		60 A/200 ms	
Max. switching capacity with resistor load	3.5 kVA/480 W		3.5 kVA/480 W		3.5 kVA/480 W		3.5 kVA/480 W	
Min. switching capacity/switching current	1 W/100 mA		1 W/100 mA		1 W/100 mA		1 W/100 mA	
Bounce times	< 3 ms		< 6 ms		< 6 ms		< 6 ms	
Switching times, typical								
–, pick-up lag	< 9 ms		< 12 ms		< 10 ms		< 4 ms	
–, turn off delay	< 10 ms		< 8 ms		< 12 ms		< 11 ms	
Max. switching frequency								
Contact material	AgCdO		AgCdO		AgCdO		AgCdO	
Service life, mechanical	3 x 10 ⁷ switching operations		3 x 10 ⁷ switching operations		3 x 10 ⁷ switching operations		3 x 10 ⁷ switching operations	
– 230 V, 50 Hz, 3.5 kV A	2.5 x 10 ⁵ switching operations		2.5 x 10 ⁵ switching operations		2.5 x 10 ⁵ switching operations		2.5 x 10 ⁵ switching operations	
Status indicator	Red LED 1128361001		Yellow LED 1150761001		Green LED 1150361001		Green LED 1150461001	
	Yellow LED 1128331001							
	Green LED 1128311001							
Storage temperature	–40 °C...+60 °C		–40 °C...+60 °C		–40 °C...+60 °C		–40 °C...+60 °C	
Ambient temperature	–25 °C...+40 °C		–25 °C...+40 °C		–25 °C...+40 °C		–25 °C...+40 °C	
Insulation coordination acc. to EN 50178								
Overvoltage category	III		III		III		III	
Pollution severity	2		2		2		2	
Dimensions								
Mounting width	25 mm		25 mm		25 mm		25 mm	
Length (perpendicular to mounting rail)	70 mm		70 mm		70 mm		70 mm	
Height with TS 32/TS 35 x 7.5	58 mm/53.5 mm		58 mm/53.5 mm		58 mm/53.5 mm		58 mm/53.5 mm	

Relay Coupler on Locking Socket Profile RS 31

RS 31

with power contacts

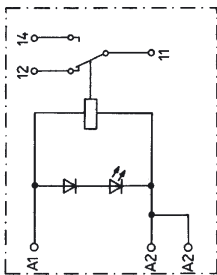

Type	Cat. No.	
RS 31, 230 V~	1128461001	
RS 31, 230 V~	1128431001	
RS 31, 230 V~	1128411001	
230 V~, +5 % -15 %		
-		
1 VA		
-		
2.2 mA~		
250 V		
16 A		

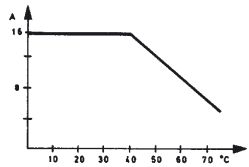

60 A/200 ms	
3.5 kVA/480 W	
1 W/100 mA	
< 6 ms	
< 10 ms	
< 8 ms	
AgCdO	
3 x 10 ⁷ switching operations	
2.5 x 10 ⁵ switching operations	
1128461001	
1128431001	
1128411001	
-40 °C...+60 °C	
-25 °C...+40 °C	
III	
2	
25 mm	
70 mm	
58 mm/53.5 mm	

Relay Couplers on Sockets RS 32

with 2 changeover contacts

RS 32

RS 32



Schematic circuit diagram

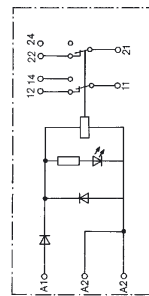

9406021001

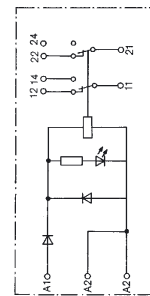

9406121001

9406321001

9406521001

Ordering data

Type	Cat. No.	Type	Cat. No.	Type	Cat. No.	Type	Cat. No.
RS 32	9406021001	RS 32	9406121001	RS 32	9406221001	RS 32	9406321001

Rated data

	12 V-, ±10 %	24 V-, ±10 %	24 V0, ±10 %	48 V-, ±10 %
Input voltage	12 V-, ±10 %	24 V-, ±10 %	24 V0, ±10 %	48 V-, ±10 %
Rated consumption - (W)	0.6 W	0.6 W	0.6 W	0.6 W
Rated consumption ~ (VA)	-	-	0.9 VA	-
Drop-out current of the relay** (at 20 °C)	9.5 mA	5 mA	24 V-: 4.5 mA	2 mA
Drop-out current of the relay** (at 20 °C)	-	-	24 V-: 2.5 mA	-
Max. output voltage	250 V	250 V	250 V	250 V
Continuous current	2 x 4 A	2 x 4 A	2 x 4 A	2 x 4 A
Derating curve	mounted horizontally on rail without clearance			

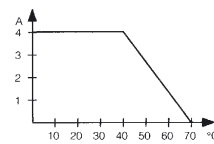
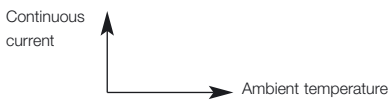

	12 V-, ±10 %	24 V-, ±10 %	24 V0, ±10 %	48 V-, ±10 %
Switch-on current	2 x 6 A	2 x 6 A	2 x 6 A	2 x 6 A
Max. switching capacity with resistor load	1400 VA	1400 VA	1400 VA	1400 VA
Min. switching capacity/switching current	-	-	-	-
Bounce times	≤ 4 ms	≤ 4 ms	≤ 4 ms	≤ 4 ms
Switching times, typical	-	-	-	-
- , pick-up lag	≤ 13 ms	≤ 13 ms	≤ 13 ms	≤ 13 ms
- , turn off delay	≤ 10 ms	≤ 10 ms	≤ 10 ms	≤ 10 ms
Max. switching frequency	-	-	-	-
Contact material	AgNi0.15, gold-flashed	AgNi0.15, gold-flashed	AgNi0.15, gold-flashed	AgNi0.15, gold-flashed
Service life, mechanical	> 30x10 ⁶ switching operations	> 30x10 ⁶ switching operations	> 30x10 ⁶ switching operations	> 30x10 ⁶ switching operations
- , 24 V-, 1 A, resistive load	-	-	-	-
- , 230 V-, 3 A, resistive load	-	-	-	-
Status indicator	Red LED	Red LED	Red LED	Red LED
Storage temperature	-40 °C...+60 °C	-40 °C...+60 °C	-40 °C...+60 °C	-40 °C...+60 °C
Ambient temperature	-25 °C...+40 °C	-25 °C...+40 °C	-25 °C...+40 °C	-25 °C...+40 °C
Approvals	-	CSA	-	CSA
Insulation coordination acc. to EN 50178				
Overvoltage category	III	III	III	III
Pollution severity	2	2	2	2
Dimensions				
Mounting width	25 mm	25 mm	25 mm	25 mm
Length (perpendicular to mounting rail)	70 mm	70 mm	70 mm	70 mm
Height with TS 32/TS 35 x 7.5	68 mm/63.5 mm	68 mm/63.5 mm	68 mm/63.5 mm	68 mm/63.5 mm

Relay Couplers on Sockets RS 32

RS 32

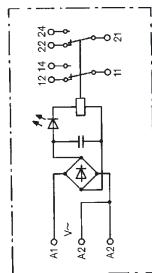
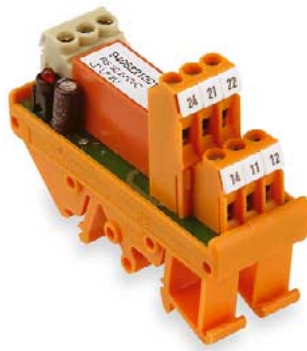

9406221001
9406421001
9406621001
9406721001

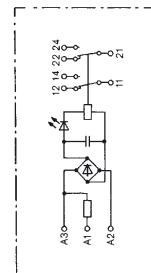

1122661001
1122761001

Type	Cat. No.	Type	Cat. No.	Type	Cat. No.	Type	Cat. No.	Type	Cat. No.	Type	Cat. No.
RS 32	9406421001	RS 32	9406521001	RS 32	9406621001	RS 32	9406721001	RS 32	1122661001	RS 32	1122761001
48 V₀, ±10 %		60 V₋, ±10 %		115 V₀, +5 % -15 %		230 V₀, +5 % -15 %		24 V/48 V₀, ±10 %		115 V/230 V₀, +5 % -15 %	
0.6 W		0.6 W		0.5 W		1 W		0.5 W/0.6 W		0.5 W/1 W	
0.9 VA		-		0.6 VA		1 VA		0.7 VA/0.9 VA		0.6 VA/1 VA	
48 V ₋ : 2 mA		1.5 mA		115 V ₋ : 1 mA		230 V ₋ : 1.2 mA		-: 5 mA/2 mA		-: 1 mA/1.2 mA	
48 V ₋ : 4.5 mA		-		115 V ₋ : 1.5 mA		230 V ₋ : 2 mA		-: 3 mA/4.5 mA		-: 1.5 mA/2 mA	
250 V		250 V		250 V		250 V		250 V		250 V	
2 x 4 A		2 x 4 A		2 x 4 A		2 x 4 A		2 x 4 A		2 x 4 A	

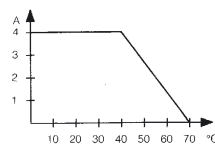

2 x 6 A	2 x 6 A	2 x 6 A	2 x 6 A	2 x 6 A	2 x 6 A
1400 VA	1400 VA	1400 VA	1400 VA	1400 VA	1400 VA
≤ 4 ms	≤ 4 ms	≤ 4 ms	≤ 4 ms	≤ 4 ms	≤ 4 ms
≤ 13 ms	≤ 10 ms	≤ 13 ms	≤ 13 ms	≤ 13 ms	≤ 13 ms
≤ 10 ms	≤ 10 ms	≤ 10 ms	≤ 10 ms	≤ 10 ms	≤ 10 ms
AgNi0.15, gold-flashed	AgNi0.15, gold-flashed	AgNi0.15, gold-flashed	AgNi0.15, gold-flashed	AgNi0.15, gold-flashed	AgNi0.15, gold-flashed
> 30x10 ⁶ switching operations	> 30x10 ⁶ switching operations	> 30x10 ⁶ switching operations	> 30x10 ⁶ switching operations	> 30x10 ⁶ switching operations	> 30x10 ⁶ switching operations
Red LED	Red LED	Red LED	Red LED	Green LED	Green LED
-40 °C...+60 °C	-40 °C...+60 °C	-40 °C...+60 °C	-40 °C...+60 °C	-40 °C...+60 °C	-40 °C...+60 °C
-25 °C...+40 °C	-25 °C...+40 °C	-25 °C...+40 °C	-25 °C...+40 °C	-25 °C...+40 °C	-25 °C...+40 °C
III	III	III	III	III	III
2	2	2	2	2	2
25 mm	25 mm	25 mm	25 mm	25 mm	25 mm
70 mm	70 mm	70 mm	70 mm	70 mm	70 mm
68 mm/63.5 mm	68 mm/63.5 mm	68 mm/63.5 mm	68 mm/63.5 mm	68 mm/63.5 mm	68 mm/63.5 mm

Multiple Socket Interface RSM

(Relay Coupler)

with one changeover contact each

RSM 4 R 4 relays, soldered

RSM 4 RS 4 relays, plug-in

RSM 8 R 8 relays, soldered

RSM 8 RS 8 relays, plug-in

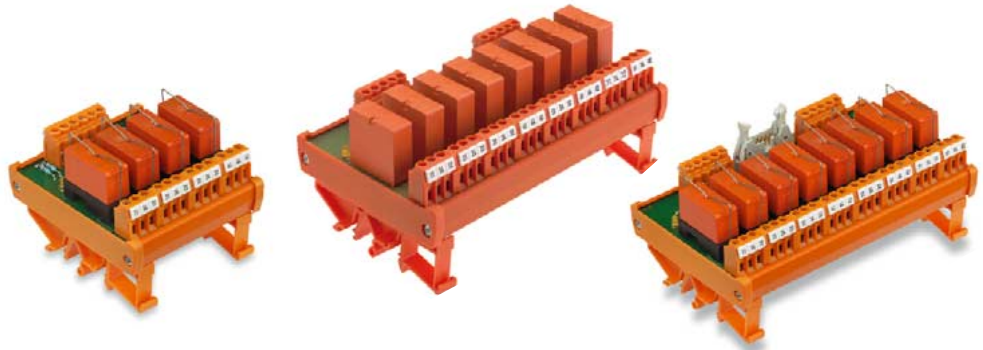

Also available as opto-coupler (max. 48 V),
See page 120/121

Schematic circuit diagram

Fixing feet can also be mounted turned through 180°

DC voltage, positive switching

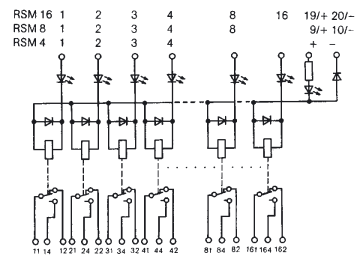

Rated data	
Input voltage	
Rated consumption ~ (W)	soldered relay
	plug-in relay
Rated consumption ~ (VA)	soldered relay
	plug-in relay
Pick-up current ~ (mA)	soldered relay
- (mA)	plug-in relay
Pick-up current ~ (mA)	soldered relay
- (mA)	plug-in relay
Drop-out current of the relay (at 20 °C)	
Max. output voltage	
Continuous current	

24 V~	24 V0	48 V~	48 V0	115 V~	115 V0	230 V~	230 V0
0.45 W	0.45 W	0.45 W	0.45 W	-	-	-	-
0.55 W	-	0.55 W	-	-	-	-	-
-	-	-	-	0.6 VA	0.6 VA	1.2 VA	1.2 VA
12 mA	-	10 mA	-	-	5 mA	-	3 mA
23 mA	12 mA	14 mA	-	-	-	-	-
-	-	-	-	-	6 mA	-	3.5 mA
-	16.5 mA	-	-	5 mA	-	4 mA	-
2 mA		1.5 mA		1 mA		1 mA	
250 V	250 V	250 V	250 V	250 V	250 V	250 V	250 V
6 A	6 A	6 A	6 A	6 A	6 A	3 A	3 A

Derating-curve
a = mounted horizontally on rail without clearance
b = mounted horizontally on rail with clearance ≥ 20 mm

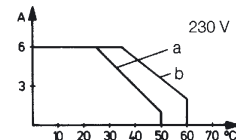
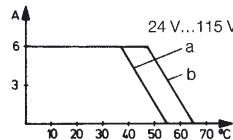

Switching times, typical							
- , pick-up lag (-/-)	≤ 8 ms	≤ 10 ms/10 ms	≤ 12 ms	≤ 10 ms/12 ms	≤ 10 ms	≤ 8 ms/10 ms	≤ 10 ms
- , turn off delay (-/-)	≤ 7 ms	≤ 15 ms/20 ms	≤ 11 ms	≤ 15 ms/20 ms	≤ 10 ms	≤ 5 ms/8 ms	≤ 10 ms
Bounce times	≤ 3 ms	≤ 3 ms	≤ 3 ms	≤ 3 ms	≤ 3 ms	≤ 3 ms	≤ 3 ms
Switch-on current	8 A	8 A	8 A	8 A	8 A	8 A	8 A
Switching capacity with resistive load	2000 VA	2000 VA	2000 VA	2000 VA	2000 VA	2000 VA	2000 VA
Min. switching capacity/switching current	250 mW/10 mA						
Contact material	AgNi 90/10, AgNi0,15, gold-flashed						
Service life, mechanical	$> 30 \times 10^6$ switching operations						
- , 24 V~, 1 A, resistive load	$> 5 \times 10^5$ switching operations						
- , 230 V~, 3 A, resistive load	$> 7 \times 10^5$ switching operations						
Storage temperature	-40 °C... $+60$ °C						
Ambient temperature	-25 °C... $+50$ °C						
Insulation coordination acc. to EN 50178							
Overtoltage category	III						
Pollution severity	2						

Dimensions			
Conductor cross-section (screw connection)	0.5...2.5 mm ²		
Spare relay (pluggable)	Input voltage	Contact material	Cat. No.
for 24 V-RSM types	24 V~	AgNi 90/10	8630780000
	24 V~	AgNi 90/10	4058480000
for 48 V-RSM types	48 V~	AgNi 90/10	8630790000
	48 V~	AgNi 90/10	4058740000
for 115 V, 230 V-RSM types	115 V~	AgNi 90/10	8630770000
	115 V~	AgNi 90/10	4058500000
	115 V~	Au 5	4156970000
			Notes
			RT 314024 with yoke
			RT 314024 without yoke
			RT 314048 with yoke
			RT 314048 without yoke
			RT 314110 with yoke
			RT 314110 without yoke
			ZLT input relay KHU/BV 1680

Multiple Socket Interface RSM

RSM 16 RS

16 relays, plug-in



Red LEDs, further colours on request

DC voltage, negative switching

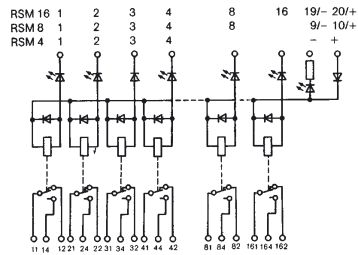

AC-DC/DC voltage

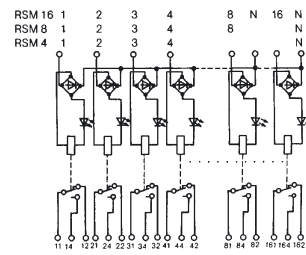

Ordering data	Input voltage	RSM 4 R/RS 4 relays	RSM 8 R/RS 8 relays	RSM 16 R/RS 16 relays	Positive switching ¹⁾	Negative switching ²⁾	Relay pluggable	Relay pluggable	Relay soldered	Mounted width
Ribbon cable/	24 VDC		●		●		-		1113161001	145 mm
Screw connection			●			●			1100061001	145 mm
Male connector block with interlock according to DIN 41651/Parts 1 and 2				●	●				1113261001	285 mm
				●		●			1100161001	285 mm
Screw connection	24 VDC	●			●		1113361001 ³⁾	8017581001 ⁴⁾	1112361001	75 mm
		●				●	1113461001 ³⁾		1112761001	75 mm
• Input: -Relay pluggable			●		●		1113561001 ³⁾ •	8003671001 ⁴⁾ •	1107761001	145 mm
Screw connection and male conn. block acc. to IEC 603-1/ DIN 41651			●			●	1113661001 ³⁾ •		1112661001	145 mm
-Relay soldered				●	●		1113761001 ³⁾ •	8018221001 ⁴⁾ •	1107861001	285 mm
male conn. block acc. to IEC 603-1/ DIN 41651				●		●	1113861001 ³⁾ •		1113061001	285 mm
• Output: Screw connection	24 V0	●					1173461001			75 mm
			●				1173561001			145 mm
				●			1173661001			285 mm
	48 VDC	●			●		1113961001		1112461001	75 mm
		●				●	1114061001			75 mm
			●		●		1114161001 •			145 mm
			●			●	1114261001 •			145 mm
				●	●		1114361001 •			285 mm
				●		●	1114461001 •			285 mm
	48 V0	●					1173761001			75 mm
	115 V0	●					1114561001			75 mm
			●				1114661001			145 mm
				●			1114761001			285 mm
	230 V-	●					1114861001			75 mm
			●				1114961001			145 mm
				●			1115061001			285 mm
	230 V0	●						1123461001		75 mm
			●					1108061001		145 mm
				●				1108261001		285 mm

Spare relays on request

¹⁾ Common negative potential, positive is switched
²⁾ Common negative potential, negative is switched

³⁾ Approval by the Germanischer Lloyd
⁴⁾ Empty modules without relays

Relay Socket Module for Industry Relays

Weidmüller relay sockets for mounting rails enable plug-in relays most commonly used in industry to be mounted; they make possible installations in which the control section and power section are perfectly separated. The coil terminals and the connection terminals are located on opposite sides of the locking socket modules.

The conductors are connected via screw terminals; the securing in the terminal is achieved by a clamping yoke system. This method has been used by Weidmüller for many years, and is the only method that guarantees a reliable connection in industrial applications.

Thanks to their combination foot, these modules can be mounted onto TS 32, TS 35x7.5, TS 35x15 mounting rails in accordance with European standards EN 50035 and EN 50022.

The connections are marked according to European Standard EN 50005. The modules are designed for DC relays (with a damping diode parallel to the coil, as well as a protection diode for reverse polarity protection) and AC relays.

They can be provided with an LED on request.

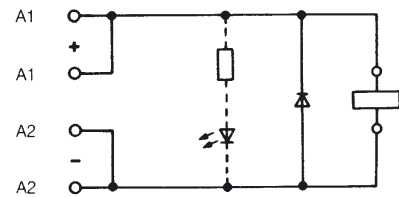

DC voltage

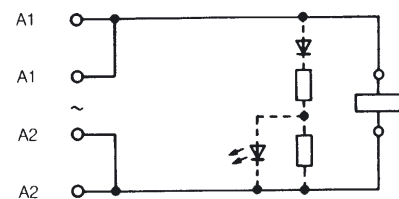

Ac voltage

The input terminals are doubled, in order to pick off the poles. Note the following for DC current operation:

A1 = +

A2 = -

The contacts available at the output are: 2, 3 or 4 changeover contacts.

The marking of the contacts in the following diagram corresponds to European standard EN 50005.

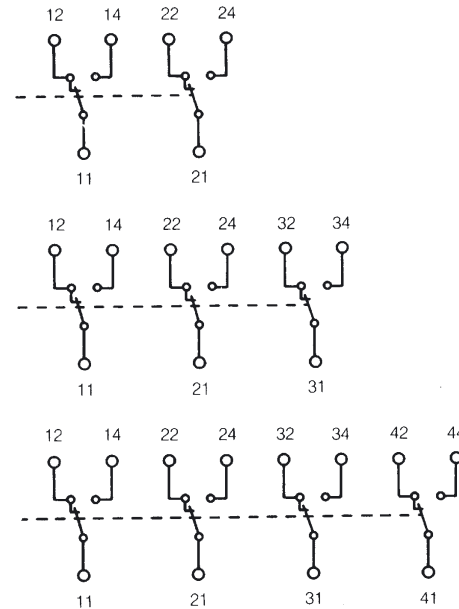

The standard range of relay socket modules is divided as follows:

Group 1:

RS 3 (2 changeover contacts)

RS 4, RS 14 (4 changeover contacts)

For relays of the type "international"

Group 2:

RS 6 (2 changeover contacts) Size 1

RS 7, 17 (3 changeover cont.) Size 2

RS 8, 18 (4 changeover cont.) Size 2

RS 9 (2 changeover cont.) Size 2

For relays of the type "European".

Relays with 4 changeover contacts (size 2) can be secured to RS 7, RS 17 and RS 9; however, only 3 or 2 changeover contacts are connected to the terminals, which results in space savings.

Group 3: RS 21 (2 changeover contacts)

RS 23 (3 changeover contacts)

RS 24 (2 x 3 changeover cont.)

For relays with one socket with 8 or 11 pins.

The table on page 87 offers an overview of the most important manufacturers of relays in groups 2, 3 and 4. The list is provided for information purposes only, and does not claim to be complete

List of Plug-in Relays for Weidmüller Relay Socket Modules

Manufacturer	Group 1	Group 2	Group 3
	International relays	European relays	Relays with socket oktal
	<ul style="list-style-type: none"> • RS 3 2 changeover contacts • RS 4, RS 14 4 changeover contacts 	<ul style="list-style-type: none"> • RS 6 2 changeover contacts (Size 1) • RS 7, RS 17 3 changeover cont. (Size 2) • RS 8, RS 18 4 changeover cont. (Size 2) • RS 9 2 changeover cont. (Size 2) 	<ul style="list-style-type: none"> • RS 21 2 changeover contacts • RS 23 3 changeover contacts • RS 24 2x3 changeover contacts
	Relay type	Relay type	Relay type
EBERLE	• –	• –	• –
	• –	• Type 40701	• Type 41454
		• Type 40701	• Type 41454
ELESTA	• –	• –	• SKR 085
	• –	• –	• SKR 115
FEME	• –	• –	• RCP 8
	• –	• –	• RCP 11
		• –	• RCP 11
GRUNER	• –	• Series 9065 G	• Series 668 B 2 changeover contacts
	• –	• Series 9059 G/9066 G	• Series 668 A 3 changeover contacts
		• Series 9059 G/9066 G	• Series 668 A 3 changeover contacts
		• Series 9059 G/9066 G	
HALLER	• –	• Series H-561 Size 1	• HB-1/1
	• –	• Series H-561 Size 2	• HB-1/2
		• Series H-561 Size 2	• HB-1/2
		• Series H-561 Size 2	
ITT (MTI)	• MAT 2	• Type 24	• –
	• MAT 4	• Type 25	• –
		• Type 25	• –
		• Type 25	
FUJITSU	• FRL 263-02	• –	• FRL 256-02
	• FRL 263-04	• –	• FRL 256-04
		• –	• FRL 256-04
		• –	
KUHNKE	• –	• –	• Universal relays-M/-H/-U
	• Type 111 A4	• –	• Universal relays-M/-H/-U
		• –	• Universal relays-M/-H/-U
		• –	
KUKE	• –	• Miniature relays Type 01	• –
	• –	• Miniature relays Type 02	• –
		• Miniature relays Type 02	• –
		• Miniature relays Type 02	
NATIONAL	• HC 2	• –	• –
	• HC 4	• –	• –
		• –	• –
		• –	
OMRON	• MY 2	• MHS-2	• MK 2
	• MY 4	• MHS-4	• MK 3
		• MHS-4	• MK 3
		• MHS-4	
POTTER & BRUMFIELD	• –	• –	• Series KAP
	• Series KH	• Series R 10	• Series KAP
		• Series R 10	• Series KAP
		• Series R 10	
RAPA	• –	• Series 012 Size 1	• Series C-Type CKR
	• –	• Series 012 Size 2	• Series C-Type CKR
		• Series 012 Size 2	• Series C-Type CKR
		• Series 012 Size 2	
Tyco/SCHRACK	• ZT 4	• Relays N, S, W Size 1	• Series RN/RC
	• PT 4	• Relays N, S, W Size 2	• Series RN/RC
		• Relays N, S, W Size 2	• Series RN/RC
		• Relays N, S, W Size 2	
SDS	• HC 2	• K 2	
	• HC 4	• K 4	
		• K 4	
		• K 4	
TEC	• –	• Type 1350	• Type 1210
	• Type 1301	• Type 1360	• Type 1210
		• Type 1360	• Type 1210
		• Type 1360	
ZETTLER	• –	• AZ E 20, AZ 420, AZ 420 W	• AZ 1010 – AZ 509 2 C
	• TEC 1401	• AZ E 21, AZ 421, AZ 421 W	• AZ 1010 – AZ 509 3 C
		• AZ E 21, AZ 421, AZ 421 W	• AZ 1010 – AZ 509 3 C
		• AZ E 21, AZ 421, AZ 421 W	

Relay Sockets for Industry Relays

PT 4 industry relays

4-pole, with test button



Rated data		
Contact data		
Contact number and type		4 changeover contacts
Contact version		Single contacts
Contact material		AgNi 90/10, AgNi 90/10 htv
Max. braking capacity AC		1500 VA
Rated voltage		250 V~
Continuous current		6 A / contact
Switch-on current		12 A / contact
Min. contact rating		24V, 10 mA / 20 m, 1 mA htv
Mechanical service life		DC coil > 30x10 ⁶ AC coil > 20x10 ⁶
Response / drop out time		15/10 ms
Bounce time		5 ms
Test voltage		2.5 kV _{eff} coil / contact
Isolation acc. to IEC664		B, 60 V~/75 V
Rated voltage		250 V
Pollution severity		2
Overvoltage category		III
Insulation group / reference voltage		B/250
Approvals		VDE, UL, CSA
Miscellaneous data		
Protection class		IP50
Flammability class UL 94		V-0
Ambient temperature	DC coil	-40 ... + 70 °C
	AC coil	-40 ... + 70 °C
Weight		30g
Correspond. relay socket		
		<ul style="list-style-type: none"> Relay sockets Type RS 3, RS 4 and RS 14 Alternatives to ZT 4 see table on page 99
Ordering data		
	Type (ZT 4)	Best.-Nr
6 V~	PT 570006	8074650000
12 V~	PT 570012	8054360000
24 V~	PT 570024	1180700000
48 V~	PT 570048	8074670000
60 V~	PT 570060	8074680000
115 V~	PT 570110	8074700000
6 V~	PT 570506	8074710000
12 V~	PT 570512	8074730000
24 V~	PT 570524	1181800000
48 V~	PT 570548	1180900000
60 V~	PT 570560	8074760000
115 V~	PT 570615	1180800000
230 V~	PT 570730	1181100000
Retainer clip for SIEMENS-Relays	PT 28800	8572170000

Relay Sockets for Industry Relays

RS 3

RS 4

RS 14

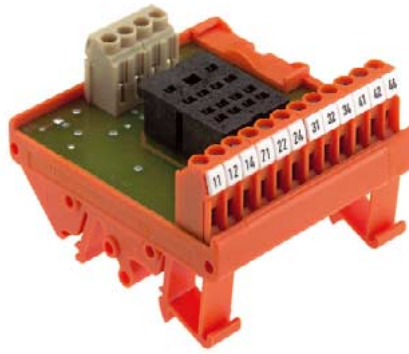
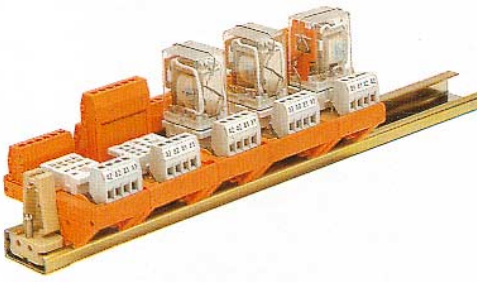

Relay sockets for DC and AC voltage relays
with fixing foot for TS 32/TS 35x7.5 and TS 35x15

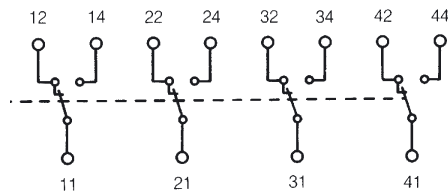

0125661001

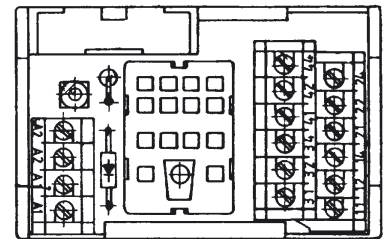

Relay type*	Schrack	Schrack	Schrack
Type PT 5	Type PT 5	Type PT 5	Type PT 5
4-pole	4-pole	4-pole	4-pole
Contacts on module	2 changeover contacts	4 changeover contacts	4 changeover contacts
Ordering data	RS 3	RS 4	RS 14
Relay socket for AC relays (without diode) With red LED (230 V~)	0115161001	0116261001	0125561001
Relay socket for DC relays with suppressor diode and reserve voltage protection (diode 1 N 4007) With red LED (24 V~)	0115061001	0116161001	0125661001
With green LED (24 V~)	0115011001	0116121001	1127661001
			8025451001
Dimensions			
Relay socket width	35 mm	65 mm	45 mm
Insulation stripping length	7 mm	7 mm	7 mm
Connection data			
Screw connection, solid	0.5...4 mm ²	0.5...4 mm ²	0.5...4 mm ²
Screw connection, flexible	0.5...2.5 mm ²	0.5...2.5 mm ²	0.5...2.5 mm ²
Conductor cross-section	AWG 26...14	AWG 26...14	AWG 26...14
Rated data			
Coil voltage (types without LED)	250 V ₀	250 V ₀	250 V ₀
Contact voltage	250 V~	125 V~	125 V~
Contact current	5 A	5 A	5 A
Accessories	Type	Cat. No.	Qty.
Mounting rail (2 m lengths)	TS 32	0122800000	-
	TS 35x7.5	0383400000	-
	TS 35x15	0498000000	-
End bracket (thickness mm)	EWK 2	0199360000	50
	EW 35	0383560000	50
Insert tag (blanc)**	ESo 7	0515200000	-
Protective strip, transparent**	SSt 7	0515300000	100
Retainer clip for Schrack relays	ZG 28800	0116000000	25

* Relay not included in delivery

Relay Sockets for Industry Relays

Relay socket for DC and AC voltage relays with locking foot for TS 32, TS 35x7.5 and TS 35x15

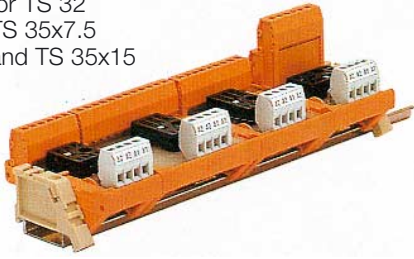

RS 6

RS 6

RS 8

RS 9

RS 17

RS 18

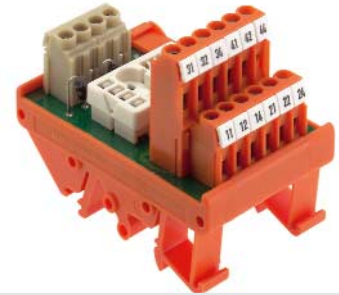

Assigning commercially available relays to the Weidmüller relay sockets RS 6...RS 24:

- Relay socket RS 6**
Siemens cradle relay, size I
Zettler cradle-operated relay AZ 420
RAPA range 012, size 1
- Relay socket type RS 7, RS 8, RS 9, RS 17 and RS 18**
Siemens cradle relay, size II
Zettler cradle-operated relay AZ 421
RAPA range 012, size II
- Relay socket type RS 21, RS 23 and RS 24**
Siemens/Schrack Universal
Industry relay RS/RN/RC
Siemens industry relay 10
Kuhnke universal relay
Zettler industrial relay AZ 1010
RAPA range C

(No claim is made that this is a complete list of manufacturers of relays or types of relays.)

0115461001

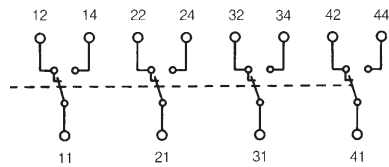
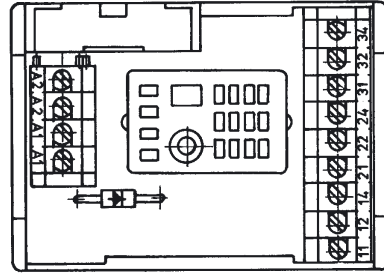

Relay type*	Relay type*	Relay type*	Relay type*
Kamm-R.® Gr. I	Kamm-R.® Gr. II	Kamm-R.® Gr. II	Kamm-R.® Gr. II
2 changeov. (e. g. B 104)	c. 3 changeov. (e. g. B 110)	c. 4 changeov. (e. g. B 110)	c. 2 changeov. (e. g. B 104)
RS 6	RS 7	RS 8	RS 9

0115361001

0115261001 0115461001 0116361001 0188961001

0126061001

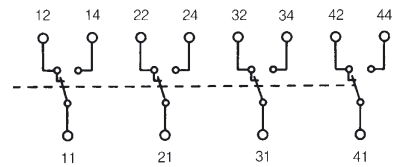
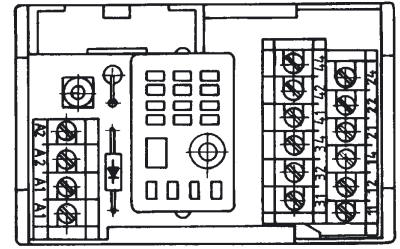

Relay type*	Relay type*
Kamm-R.® Gr. II	Kamm-R.® Gr. II
3 changeov. (e. g. B 110)	c. 4 changeov. (e. g. B 110)
RS 17	RS 18

0125861001 0126061001

0126011001

Ordering data	Socket type
Relay socket for AC relays (without diode)	
Relay socket for DC relays with suppressor diode and reserve voltage protection (diode 1 N 4007) With red LED (24 V-) With green LED (24 V-)	
Dimensions	
Relay socket width	35 mm
Insulation stripping length	7 mm
Connection data	
Screw connection, solid	0.5...4 mm ²
Screw connection, flexible	0.5...2.5 mm ²
Conductor cross-section	AWG 26...14
Rated data	
Coil voltage (types without LED)	250 V ₀
Contact voltage	250 V _~
Contact current	5 A
Accessories	
Mounting rail (2 m lengths)	TS 32 TS 35x7.5 TS 35x15 EWK 2 EW 35 ESo 7 SSt 7
End bracket (thickness mm)	
Insert tag (blanc)**	
Protective strip, transparent**	
Retainer clip for Schrack relays	

35 mm	50 mm	65 mm	35 mm
7 mm	7 mm	7 mm	7 mm
0.5...4 mm ²	0.5...4 mm ²	0.5...4 mm ²	0.5...4 mm ²
0.5...2.5 mm ²	0.5...2.5 mm ²	0.5...2.5 mm ²	0.5...2.5 mm ²
AWG 26...14	AWG 26...14	AWG 26...14	AWG 26...14

35 mm	45 mm
7 mm	7 mm
0.5...4 mm ²	0.5...4 mm ²
0.5...2.5 mm ²	0.5...2.5 mm ²
AWG 26...14	AWG 26...14

Type	Cat. No.	Qty.
TS 32	0122800000	-
TS 35x7.5	0383400000	-
TS 35x15	0498000000	-
EWK 2	0199360000	50
EW 35	0383560000	50
ESo 7	0515200000	-
SSt 7	0515300000	100

Type	Cat. No.	Qty.
TS 32	0122800000	-
TS 35x7.5	0383400000	-
TS 35x15	0498000000	-
EWK 2	0199360000	50
EW 35	0383560000	50
ESo 7	0515200000	-
SSt 7	0515300000	100

* Relay not included in delivery

** Not suitable for RS 12

Relay Coupler, Relay Sockets Module for Industry Relays

RS 21 RS 23 RS 24



0167161001

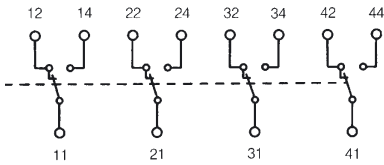
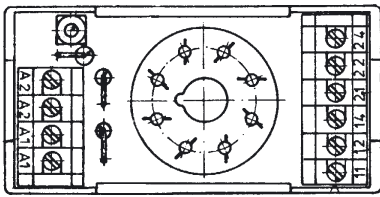

Plug-in relay for	Plug-in relay for
Octal socket	submagnal socket
8-pole	11-pole
2 changeov. c. 3 changeov. c. 2 x 3 changeov. c.	

RS 21	RS 23	RS 24
on request	8010061001	on request

0167161001	0188661001	on request
-------------------	-------------------	------------

35 mm	40 mm	75.5 mm
7 mm	7 mm	7 mm
0.5...4 mm ²	0.5...4 mm ²	0.5...4 mm ²
0.5...2.5 mm ²	0.5...2.5 mm ²	0.5...2.5 mm ²
AWG 26...14	AWG 26...14	AWG 26...14

250 V0	250 V0	250 V0
250 V~	250 V~	250 V~
6 A	6 A	6 A
Type	Cat. No.	Qty.
TS 32	0122800000	-
TS 35x7.5	0383400000	-
TS 35x15	0498000000	-
EWK 2	0199360000	50
EW 35	0383560000	50
ESo 7	0515200000	-
SSt 7	0515300000	100



Opto-coupler



With increasing automation, potential separation between the control and field sides of circuits is becoming increasingly important. The control unit being the core of the automation must be electrically safe and free from feedback when coupled with the various sensors and actuators. Opto-coupler are being used in a growing number of applications. They offer the necessary safety and have further advantages such as:

- low power uptake on control side
- high switching frequency
- no contact bounce
- wear-free switching
- insensitive to vibration
- use independent of location
- no mechanical parts
- long life
- high insulation voltage

Because of these features, opto-coupler are an alternative to conventional, mechanical relay interfaces.

For industrial usage, Weidmüller offers modules with various input voltages and housings.

Basic construction of the opto-coupler interface:

The heart of the system is the opto-electronic component (opto-coupler) that effects the coupling.

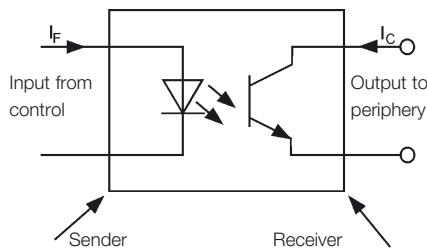

An important parameter of this type of modules is the CTR = current transfer rate.

The CTR is given in % and is the ratio between the input current I_F and the maximum available output current I_C .

Example: $I_F = 10 \text{ mA}$; $CTR = 100\%$
 $\Rightarrow I_C = 10 \text{ mA}$.

The CTR is affected by a number of parameters such as:

- Ambient temperature
- efficiency of the luminescence diode
- geometric dimensions within the module

It also drops with time. The result is that the switching levels change due to ageing.

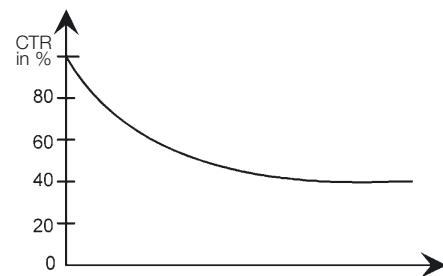

CTR as a function of operating life

To eliminate these effects where possible, Weidmüller opto-coupler use almost exclusively semiconductors which have a long life in terms of CTR.

Moreover, the insulation of a module is highly important, since the actual coupling of the input and output circuits takes place optically. Thus the optical component has to guarantee separation of both circuits even in case of a defect.

Weidmüller opto-coupler comply with DIN VDE 0884 to provide a maximum level of safety.

Appropriate switching circuits need to be included to ensure that the entire component provides reliable separation in accordance with DIN VDE 0106, Part 101.

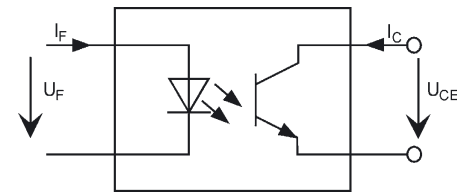

Circuit diagram of an opto-coupler

Opto-coupler for protective separation or galvanic isolation

The most important precondition for achieving protective separation with opto-electronic coupling modules is the partial discharge test in accordance with DIN VDE 0884. Double or reinforced insulation for protective separation must be discharge proof. High voltage tests, as are usual with relays, cannot be carried out with semi-conductors, because they could lead to the destruction of the semi-conductor. Safe separation for the given rated voltage is applicable to coupling modules that are integrated into opto-couplers if:

- the opto-couplers are tested according to DIN VDE 0884
- clearance and creepage distances on the PCB and connection elements correspond to EN 50 178, DIN VDE 0106 and 0109.

Control side of the opto-coupler interface

3 basic circuits are to be differentiated on the input side of the opto-coupler's interface:

- as a pure **DC input** with polarity protection diode which prevents the opto-coupler from being destroyed if the input polarity is reversed.

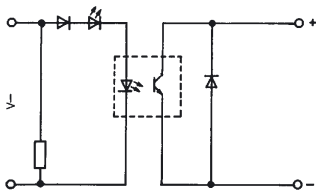

- as an **AC/DC input:**

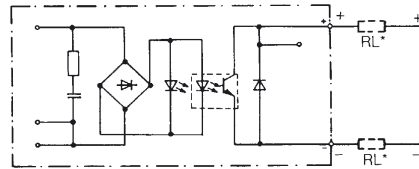

Wrong polarity of the DC input signal is not possible with this switching. The disadvantage of an AC/DC input circuit (driven by DC signal) is the low switching rate since the charging capacitor (CL, necessary for AC-input signal) lowers the max. switching rate.

- pure **AC-Input:**

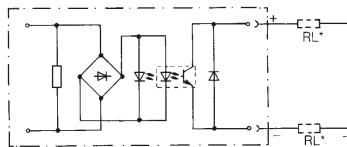

* Sample circuit

Here, too, the charging capacity lowers the max. switching rate considerably. Weidmüller opto-coupler with AC/DC or AC input signals are designed for 40...60 Hz power supply. With AC-signal input the max. switching rate is below half the power supply frequency. A high switching rate is not possible, otherwise continuous switching in tune with the power frequency would occur.

Output side of the opto-coupler

Weidmüller opto-coupler are designed and sized for a wide variety of applications. Demands regarding the load side of opto-coupler modules could be:

- power amplification
- signal conditioning AC/DC, DC/AC
- short-circuit protection
- interference proof, etc.

To fulfil these requirements, the opto-coupler must contain additional electronic components which determine the functionality of the opto-coupler. Thus there are 2 basic output variations for opto-coupler

Output as

- 2 pole and
- 3 pole circuits

2-pole DC output

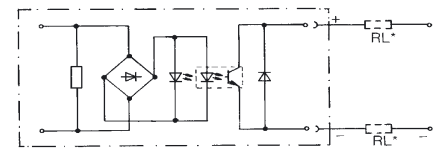

* Wiring example

The 2-pole DC output is comparable to a conventional switch. With this type it is immaterial where the load is in the output circuit. It is, however, important to provide the necessary output supply voltage with the right polarity.

Opto-coupler



Opto-couplers are normally given with an output voltage supply from 5...48 VDC. These values should not be cut or exceeded on any occasion.

The load current should not be higher than the stated max. output current. Continuously exceeding this value will destroy the output stage.

The derating curve shows the dependency of the output current as a function of the Ambient temperature (see under the respective product on the following pages).

2-pole AC output

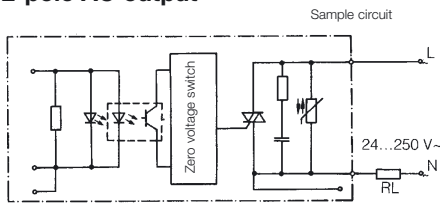

A special semiconductor element (TRIAC) in the output stage of the opto-coupler is used to switch AC voltages.

As for the DC-versions the appropriate parameters (such as voltage, frequency, max. load current, ambient temperature) should be given consideration.

A neutral voltage switch ensures that the load is switched only in the voltage zero. To protect against voltage spikes, the modules are always fitted with appropriate protection elements (varistors, RC-combination).

3-pole DC output

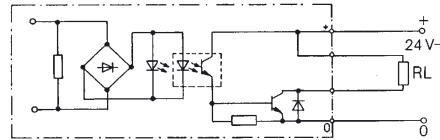

This type of output stage requires for safe function a potential-linked output voltage supply with an output that is either positive switching (common reference potential is GND or 0 V) or negative switching (common reference potential is the positive voltage pole).

Standards

Weidmüller opto-coupler comply with the following standards:

- EN 50 178
- Furnishing of power engineering systems with electronic equipment
- DIN VDE 0106 Part 101
- Protection against flow of dangerous currents into the human body; basic requirements for reliable separation within electrical equipment.
- DIN VDE 0884
- Optoelectronic coupling devices for reliable separation
- DIN VDE 0109
- Insulation coordination within low-voltage system including clearance and creepage distances for equipment

Protective circuit

All opto-coupler have a protective circuit in the output (generally a free-wheeling diode).

To prevent decoupling of interference signals to other leads the load side should be protected.

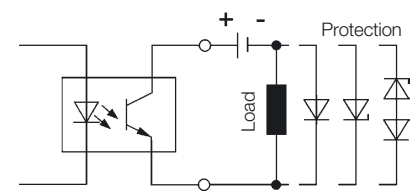

Protective circuit for DC output

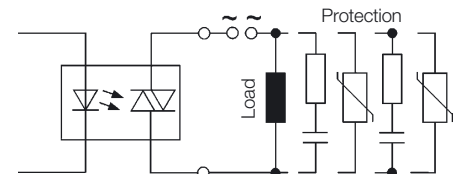

Protective circuit for AC output

Application example

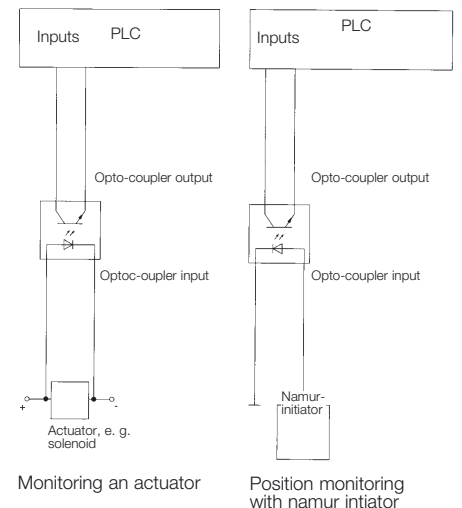

Types of housing for opto-coupler

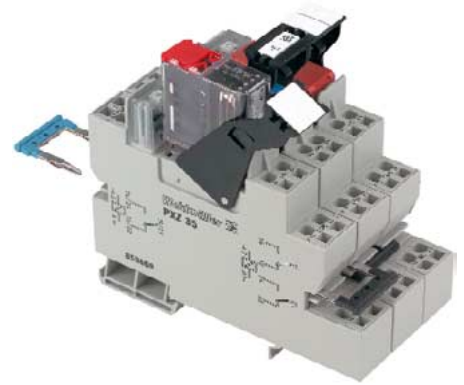

Weidmüller coupler modules are enclosed in housings that are appropriate for industrial applications. The housings are suitable for fitting onto mounting rails TS 32, TS 35 x 7.5 or TS 35 x 15 in accordance with European Standards EN 50 035 and EN 50 022.

Component housing EG

Weidmüller component housings **EG 1** and **EG 2** are 18 mm wide. The fully enclosed EG housings are fitted with clamping yoke screw connections or push-on blade connectors for attaching wires. Conductors with the following cross-sectional dimensions can be connected:

solid conductors: 0.5...4 mm² or
flexible conductors: 0.5...2.5 mm².

The component housing EG 7 has a special status. It has been specifically designed to accommodate 10-mm slim opto-couplers.

EG 7 opto-coupler modules can be mounted onto TS 32 or TS 35 rails.

The RS EG7 locking socket is also available for the OST opto-couplers.

The fully-enclosed EG 7 housing is fitted with clamping yoke connections.

Conductors with the following cross-sections can be connected:

Component housing EG7: 0.5...1.5 mm²
Locking socket: 0.5...2.5 mm².

Component Housing WAVEBOX

Component housing WAVEBOX

It is important for modern electronics to create a functional housing. Setting and operating functions must be guaranteed, technical demands regarding heat dissipation and EMC properties are to be supported. The ideal design saves space and mounting costs in the switchgear cabinet. Moreover, ergonomics and the design are gaining in importance for high-quality opto-couplers interfaces. The WAVEBOX fulfils these criteria and has the following distinguishing features:

The WAVEBOX is characterised by:

- Optimal width for any application (12.5 mm, 17.5 mm, **22.5 mm**)
- Large component assembly surface; SMD's can be mounted on the solder side
- No tools required for assembly
- Plug-in printed circuit board
- Plug-in cross-connection via ZQV 2.5 N
- Hinged, transparent cover
- BLZ 5.08 screw/plug and socket connector
- BLZF 5.08 optional tension clamp/plug and socket connector
- Marking option with WS tags
- Suitable for snap-fitting on TS 35

Connection systems

Available are BLZ screw-type connectors as well as the BLZF tension clamp system for up to 2.5 mm² flexible conductors for maximum wiring flexibility.

Printed-circuit board removal

This takes place by pushing in the locking hooks in way of the cover and with drawing of the terminal level and printed circuit board from the housing. This must not take place with the supply connected.

Cross-connection

Housings of the same family arranged side by side, can be cross-connected in the base of the housing with the ZQV 2.5 N/2 cross-connector. The cross-connection can be loaded with a current of up to 8 A. By means of this arrangement, the supply voltage can be cross-connected from one electronic module to another. The voltage transferred from the cross-connection to the terminal level must not exceed 50 V.

Air vents

Slanted air vents control the temperature and ventilate the housing base.

Modular system PLUGSERIES/PLUGOPTO

is a new generation of pluggable SSR. The core is an innovative relay socket **PXS** or **PXZ**.

Both products combine Weidmüller functionality and experience gained from the relay and terminal business. The PLUGopto is the ideal connection technology between SSR and the application.

Modular principle

The new PLUGSERIES is particularly service friendly. Commercially available SSRs are simply plugged: holding / dismantling clamps guarantee secure mounting; LED indicators with free-wheeling diode can be simply plugged.

- Easy plugging of SSR
 - suitable for the standard design and RT
- Independent connection technology: screw or tension clamp
- Robust holding / dismantling clamp
- Control voltage 24 Vac/Vdc
- Rated switching voltage 24 Vdc, 24 Vac/Vdc, 230 Vac
- Up to 5 A continuous current
- Low wiring costs thanks to ZQV 2.5N (pluggable) cross-connectors
- Service-friendly modular system
 - relay socket, LED indicator
 - holding clamp and SSR
 - mount onto TS 35
 - marking options with WS marking tags and holding clamps
- Pluggable LED indicator with free-wheeling diode

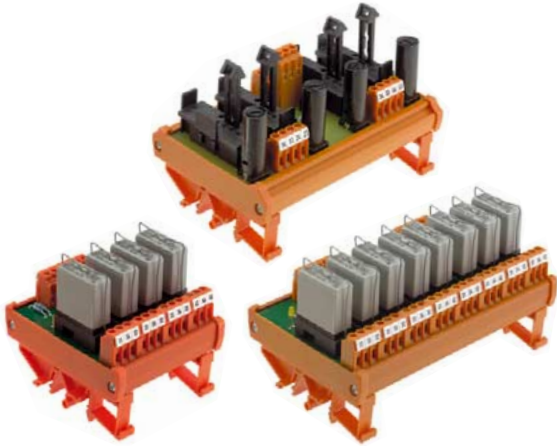

Weidmüller locking socket RS

The locking socket with opto-couplers RS 40 have a width of 11.2 mm. The modules on locking socket profiles are equipped with clamping yoke (screw connection) units for conductor connection.

Connectable are:

solid conductors: 0.5...4 mm²

flexible conductors: 0.5...2.5 mm².

Locking socket with multiple interfaces

Multiple interfaces RSM are optionally available assembled with 4, 8 or 16 plug-gable opto-couplers. Versions are available with joint positive and negative potentials in order to reduce wiring on the input side.

PCB clamping yoke screw connector elements have clamping yoke units for connecting conductors with the following cross-sections:

solid conductors: 0.5...4 mm²

flexible conductors: 0.5...2.5 mm²

Variants of the RSM couplers have male connector blocks on the input side for connecting pre-assembled cables, in accordance with IEC 603-1/DIN 41651.

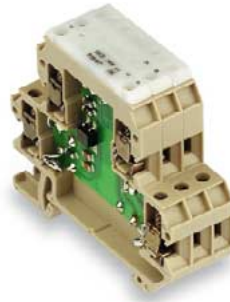

Mini-coupler

All parts of the mini-coupler DKR and DKO meet the specifications for a design that is as slim as possible. The sensational width of a mere 6 mm can be achieved by employing the latest surface-mounted devices (SMD). There are 4 or 5 screw connections available which accept conductors with cross-sectional dimensions from 0.5...4 mm². The mini-coupler offer a wide range of options for coupling digital sensor/actuator signals between automation devices and the process stage. With DKO opto-coupler, signals from the field with different voltages can be picked up and unified.

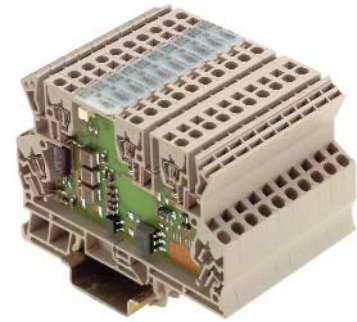

Miniconditioner MCZ

The MCZ-housing is distinguished as one of the slimmest component-housings. A tool width of only 6 mm reduces space requirements in cabinets.

The MCZ is characterized by:

- Tension-clamp connection
 - integrated cross-connection option for input and output minimise wiring costs.
- The mini conditioner MCZO (opto-couplers) have 4 and 5 Z-tension spring connections. The clampable conductor cross-section is 0.5...1.5 mm².

CE-marking

Weidmüller opto-coupler are marked with the CE symbol and comply with the requirements of EN 50 081 Part 1 and EN 50 082 Part 2. They can therefore be used for both industrial as well as for commercial and light industry.

Appropriate ESD measures should be taken during installation. If connecting wires are particularly long, overvoltage protection should be provided in order to prevent interference from electrical disturbance in the atmosphere.

Opto-coupler

Electronic switching

	Output									
Housing	5 - 48 V ≤ 20 mA	5 - 48 V ≤ 0.1 A	5 - 48 V ≤ 0.5 A	5 - 48 V ≤ 20 mA	5 - 48 V ≤ 2.5 A	5 - 48 V ≤ 5 A	24 - 250 V ≤ 3.5 A	5 - 48 V ≤ 0.1 A	5 - 48 V ≤ 0.1 A	5 - 48 V ≤ 0.1 A
EG	● 0558160000 Page 122	● 0609860000 Page 123				● 8220870000 Page 130				
WAVESERIES WOS						● 8275190000 Page 126		● 8237720000 Page 128		
EG 7					● 8269050000 Page 131	● 8281720000 Page 131				
RS 40		● 8092530000 ● 8234580000 Page 132								
RSM		● 1160961001 ● 1161761001 ● 1177860000 Page 137	● 1117461001 ● 8065031001 ● 1119460000 Page 137					● 1123861001 ● 1123761001 ● 1125161001 ● 8017581001 ● 1124900000 ● 1124900000 ● 1170200000 ● 1153200000 ● 1121300000 ● 1121300000 Page 139	● 1124261001 ● 1125261001 ● 8003671001 ● 1124900000 ● 1170200000 ● 1153200000 ● 1121300000 ● 8021391001 ● 1124900000 ● 1170200000 ● 1153200000 ● 1121300000 Page 139	● 1124661001 ● 8018220000 ● 1124900000 ● 1170200000 ● 1153200000 ● 1121300000 ● 8082471001 ● 1124900000 ● 1170200000 ● 1153200000 ● 1121300000 Page 139
DKO 32	● 8008090000 Page 116		● 8019580000 Page 117							
DKO 35	● 8008150000 Page 116 ● 8028300000 ● 8215640000 ● 8248790000 Page 117		● 8019590000 Page 117 ● 8215630000 Page 118		● 8215600000 ● 8181990000 Page 118					
DKO 35/32	● 8228640000 Page 119				● 8228630000 Page 118					
MCZ O	● 8365940000 Page 114	● 8398940000 Page 115			● 8287730000 Page 114					
PLUGSERIES POS/POZ	● 8324610000 (5 V TTL) Page 115					● 8610840000 ● 8610920000 ● 8610900000 ● 8610970000 ● 8610890000 ● 8610960000 ● 8615600000 ● 8615640000 ● 8615620000 ● 8615650000 Page 134	● 8610860000 ● 8610930000 ● 8610910000 ● 8610980000 ● 8615590000 ● 8615630000 Page 134			

Reliable separation

● 24 V dc
● 24 Vuc/ac

● Replacement opto-coupler dc and ac/dc
● Empty socket

Opto-coupler

Electronic switching

48 V

Output



Housing	5 - 48 V ≤ 20 mA	5 - 48 V ≤ 0.1 A	5 - 48 V ≤ 0.5 A	5 - 48 V ≤ 20 mA	5 - 48 V ≤ 2.5 A	5 - 48 V ≤ 5 A	24 - 250 V ≤ 3.5 A	5 - 48 V ≤ 0.1 A	5 - 48 V ≤ 0.1 A	5 - 48 V ≤ 0.1 A
EG 7		● 8092550000 Page 132								
		● 8234590000 Page 132								
RS 40		● 1161061001 Page 137								
		● 1161860000 Page 137								
DKO 35	● 8151230000 Page 120									

115 V

Output

















Housing	5 - 48 V ≤ 20 mA	5 - 48 V ≤ 0.1 A	5 - 48 V ≤ 0.5 A	5 - 48 V ≤ 20 mA	5 - 48 V ≤ 2.5 A	5 - 48 V ≤ 5 A	24 - 250 V ≤ 3.5 A	5 - 48 V ≤ 0.1 A	5 - 48 V ≤ 0.1 A	5 - 48 V ≤ 0.1 A
EG		● 0131860000 Page 123								
WAVESERIES WOS			● 8235180000 Page 125			● 8296250000 Page 126	● 8259950000 Page 127	● 8275360000 Page 128		
EG 7		● 8092570000 ● 8234600000 ● 8397420000 ● 8315590000 Page 133								
RS 40		● 1161161001 ● 1161960000 Page 137								
DKO 32	● 8027980000 Page 119									
DKO 35	● 8077860000 Page 119 ● 8131660000 Page 120									
MCZ O		● 8421060000 Page 114								

Digital signal processing

Reliable separation ● Vdc ● Vuc/ac

Opto-coupler

Electronic switching

	Output													
														
Housing		5 - 48 V ≤ 20 mA	5 - 48 V ≤ 0.1 A	5 - 48 V ≤ 0.5 A	5 - 48 V ≤ 20 mA	5 - 48 V ≤ 2.5 A	5 - 48 V ≤ 5 A	24 - 250 V ≤ 3.5 A	5 - 48 V ≤ 0.1 A	5 - 48 V ≤ 0.1 A	5 - 48 V ≤ 0.1 A	5 - 48 V ≤ 0.1 A	5 - 48 V ≤ 0.1 A	5 - 48 V ≤ 0.1 A
EG			● 0546360000 Page 123											
WAVESERIES WOS				● 8275380000 Page 125			● 8275220000 Page 126	● 8275400000 Page 127	● 8275340000 Page 128					
EG 7			● 8092590000 ● 8234610000 ● 8387580000 ● 8394990000 Page 133											
RS 40			● 1161461001 ● 1162060000 ● 8182690000 Page 137											
DKO 32		● 8008100000 Page 119												
DKO 35		● 8008160000 Page 119												
MCZ O		● 8421380000 Page 114												

● 230 V_{uc/ac}

Opto-coupler

Electronic switching

	Output									
								4 x	8 x	16 x
12 V										
Housing	5 - 48 V ≤ 20 mA	5 - 48 V ≤ 0.1 A	5 - 48 V ≤ 0.5 A	5 - 48 V ≤ 20 mA	5 - 48 V ≤ 2.5 A	5 - 48 V ≤ 5 A	24 - 250 V ≤ 3.5 A	5 - 48 V ≤ 0.1 A	5 - 48 V ≤ 0.1 A	5 - 48 V ≤ 0.1 A
EGO	● 8011250000 Page 122	● 0114260000 Page 122								
WAVESERIES WOS			● 8275500000 Page 124							
EGO 7		● 8092510000 ● 8234570000 Page 132								
RS 40		● 1118760000 ● 1161660000 Page 137								
RSM O							● 8017581001 ● 1121200000 ● 1124800000 Page 139	● 8003671001 ● 1121200000 ● 1124800000 ● 8021391001 ● 1121200000 ● 1124800000 Page 139	● 8018221001 ● 1121200000 ● 1124800000 ● 8082471001 ● 1121200000 ● 1124800000 Page 139	
DKO 35		● 8184030000 Page 116								
3...60 V										
EGO, 3...5 V	● 0266160000 Page 122									
EGO, 3...12 V	● 8011250000 Page 122									
WAVESERIES WOS 5 V					● 8275430000 Page 124					
WAVESERIES WOS 5 V TTL		● 8275210000 Page 129								
WAVESERIES WOS 3.5 - 15 V		● 8275390000 Page 124								
WAVESERIES WOS 12 - 28 V		● 8275450000 Page 129								
WAVESERIES WOS 15 - 60 V		● 8237730000 Page 124	● 8237730000 Page 124			● 8275440000 Page 127				
EGO, 7.5 V			● 8092490000 ● 8234560000 Page 132							
RS 40, 5 V	● 1118861001 ● 1161560000 Page 137									
RSM, 5 V							● 1123661001 ● 1121100000 Page 139	● 1124061001 ● 1121100000 Page 139	● 1124461001 ● 1121100000 Page 139	
DKO 32	● 8018620000 Page 116									
DKO 35	● 8018630000 Page 116	● 8067100000 Page 120								
DKO 32/35		● 8228650000 Page 116								

Reliable separation ● 12 Vdc ● Replacement opto-coupler dc and ac/dc
● 12 Vuc/ac ● Empty socket

Opto-coupler in component housing mini coupler MCZ

Opto-couplers MCZ O

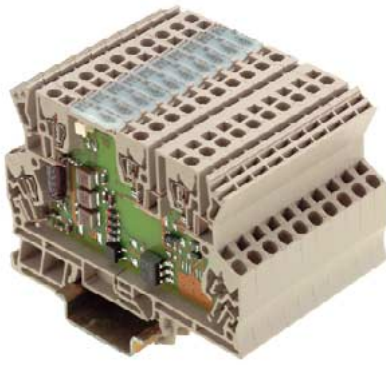

Schematic circuit diagram

This module can be used:

- between controller and sensor, for feedback of different statuses.
- for direct switching of load currents up to a Adc, but also provides "online" information about the behaviour of the load current.

The MCZ-O modules do have following features:

- Reduction of installation- and power-up times by using the proved tension-clamp technology
- Pluggable cross-connection units in the input side reduce wiring costs
- 6 mm width

MCZ O 24 Vac/dc 20 mA

Derating curve
rated to ambient temperature

a = rowed without clearances on the mounting rail
b = rowed with clearances ≥ 20 mm

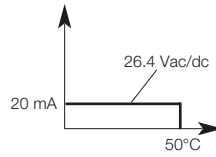

MCZ O 24 Vac/dc 2 A²

Output current

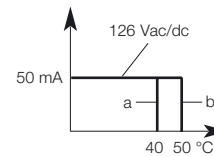
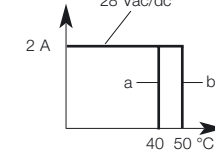
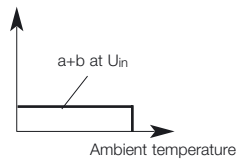

MCZ O 230 Vac

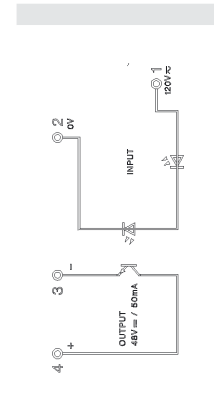
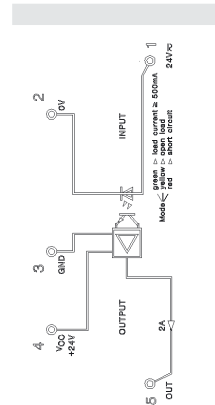
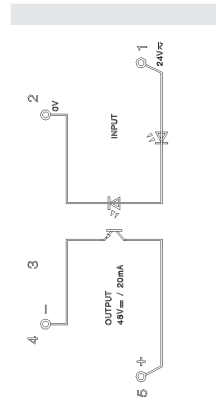
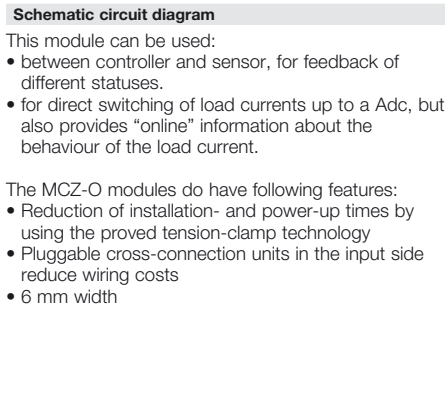
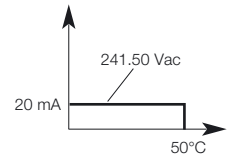

Ordering data

For TS 35

Type	Cat. No.
MCZ O 24 Vac/dc	8365940000

Type	Cat. No.
MCZ O 24 Vac/dc	8287730000

Type	Cat. No.
MCZ O 120 Vac/dc	8421060000

Type	Cat. No.
MCZ O 230 Vac	8421380000

Technical data

Input	MCZ O 24 Vac/dc	MCZ O 24 Vac/dc	MCZ O 120 Vac/dc	MCZ O 230 Vac
Input voltage	24 Vac/dc $\pm 10\%$ (21.6...26.4ac/dc)	24 Vac/dc $\pm 20\%$ (19.2...28.8ac/dc)	120 Vac/dc -15% +5%	230 Vac -15% +5%
Making threshold	ac: 14.1 Vac / dc: 16.8 Vdc	approx. 16 Vac/dc	approx. 65 Vac/approx. 70 Vdc	approx. 170 Vac
Input current at U_{nom}	ac: 11.4 mA / dc: 9.6 mA	ac: 13 mA / dc: 12 mA	approx. 3 mA	ac: 10 mA
Rated input consumption		ac: approx. 220 mW		
Max. input frequency	ac: 5 Hz duty factor 1:2 dc: 10 Hz duty factor 1:2	ac: ≤ 10 Hz duty factor 1:2 dc: ≤ 30 Hz duty factor 1:2	ac: 5 Hz duty factor 1:2 dc: 20 Hz duty factor 1:2	ac: 5 Hz duty factor 1:2
Capacity working resistance to reduction at dissipated energy	no	no	no	yes
Functionality	operating indication	operating indication	operating indication	operating indication
Output				
Supply voltage	5...48 Vdc	24 Vdc $\pm 20\%$ (19.2...28.8 Vdc)	5...48 Vdc	5...48 Vdc
Max. output current	20 mA	2 A	50 mA	20 mA
Voltage drop at max. load current	≤ 1 V		< 1.6 V	< 1.6 V
Pulse duration, limiting overload current (not periodic)	< 150 mA / 10 ms		< 150 mA / 10 ms	< 150 mA / 10 ms
Reverse current (close-circuit current) at $U_{out} = 48$ V	max. 0.16 mA		max. 0.16 mA	max. 0.16 mA
Reverse polarity protection		present		present
Free-wheel diode	present	external necessary	present	present
- typ. Switch-on delay (at ac phase position dependent)	ac: ≤ 10 ms / dc: ≤ 20 ms		≤ 30 ms	
- typ. Switch-off delay (at ac phase position dependent)	ac: ≤ 45 ms / dc: ≤ 40 ms		≤ 40 ms	
Short-circuit proof		yes		
Insulation coordin./Reliable separation acc. to EN 50 178				
Rated voltage	300 V	300 V	300 V	300 V
Rated impulse voltage	6 kV	6 kV	6 kV	6 kV
Overvoltage category	III	III	III	III
Pollution severity	2	2	2	2
Clearances and creepage distances	≥ 5.5 mm	≥ 5.5 mm	≥ 5.5 mm	≥ 3 mm
Insulation coordin.- and voltage proof, input/output mounting rail	4 kV _{eff} / 1 min	4 kV _{eff} / 1 min	4 kV _{eff} / 1 min	4 kV _{eff} / 1 min
Opto-coupler	acc. to VDE 0884	acc. to VDE 0884	acc. to VDE 0884	acc. to VDE 0884
Ambient temperature rowed on mounting rail without clearances	-25 °C...+50 °C	-25 °C...+40 °C	-25 °C...+40 °C	-25 °C...+50 °C
Ambient temperature rowed with clearances ≥ 20 mm		-25 °C...+50 °C	-25 °C...+50 °C	
Storage temperature	-40 °C...+85 °C	-40 °C...+60 °C	-40 °C...+60 °C	-40 °C...+85 °C
Conductor	AWG 22...12	AWG 22...12	AWG 22...12	AWG 22...12
Conductor cross-section	1.5 mm ²	1.5 mm ²	1.5 mm ²	1.5 mm ²
Approvals	CE, UL, CSA	CE, UL, CSA	CE, UL, CSA	CE, UL, CSA
Overall width	6 mm	6 mm	6 mm	6 mm
Accessories	Type	Type	Type	Type
End plate	AP MCZ 1.5	AP MCZ 1.5	AP MCZ 1.5	AP MCZ 1.5
Further accessories, dimensions and connection data	8389030000 Page 305	8389030000 Page 305	8389030000 Page 305	8389030000 Page 305

Opto-coupler in component housing mini coupler MCZ

Opto-couplers MCZ O

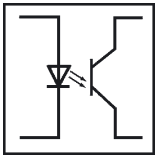

This module can be used:
 1* - between controller and actuator, for the signal conversion of 24 Vdc to 5 VTTL
 2* - between controller and actuator, for the signal conversion of 5 VTTL to 5...48 Vdc

MCZ O 24 Vdc/5 VTTL^{1*}

Derating curve
 rated to ambient temperature

a = rowed on the mounting rail without clearances
 b = rowed with clearances ≥ 20 mm

MCZ O 5 V TTL/5...48 Vdc^{2*}

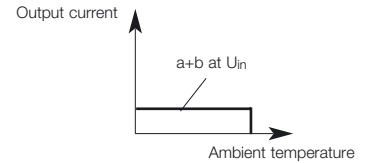
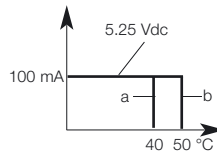
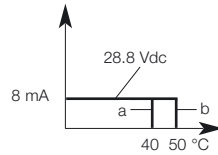

Schematic circuit diagram

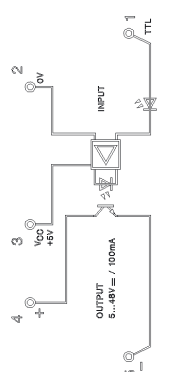
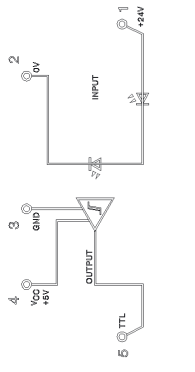
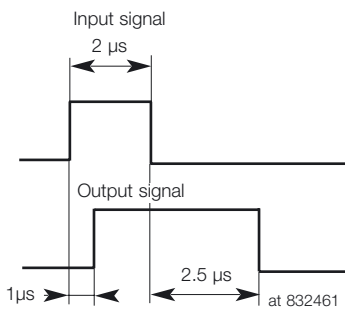

Ordering data

For TS 35

Type	Cat. No.	Type	Cat. No.
MCZ O 24 Vdc	8324610000	MCZ O 24 Vdc	8398940000

Technical data

Input	MCZ O 24 Vdc	MCZ O 5 V TTL
Supply voltage	24 Vdc $\pm 16\%$ (20...28 Vdc)	5 Vdc $\pm 5\%$
Input voltage	approx. 17 Vdc	5 V TTL
Making threshold	4.7 mA (2.9...6.5 mA)	$I_{IH} = 1 \mu A / I_{HI} = 8 \mu A$
Input current at U_{nom}	dc: 112 mW	2.4 kHz
Rated input consumption	100 kHz switching ratio 1:2	
Max. input frequency	50 kHz switching ratio 1:10	
Min. input impulse width	2 μs	
Output		
Supply voltage	5 V (4.75...5.25 V)	5...48 Vdc
Output voltage	5 V TTL (4.75...5.25 V)	100 mA
Max. output current	8 mA, Fan Out = 20 LS-TTL	≤ 1.8 V
Voltage drop at max. load current		
Pulse duration, limiting overload current (not periodic)		
Reverse current (static current) at $U_{out} = 48$ V		
Reverse polarity protection		present (input)
Free-wheel diode		present
- typ. switch-on delay	1 μs (at 20 Vdc)	approx. 27 μs
- typ. switch-off delay	2.5 μs (at 28 Vdc)	approx. 210 μs

Insulation coordin./Reliable separation acc. to EN 50178

Rated voltage	MCZ O 24 Vdc	MCZ O 5 V TTL
Rated voltage	300 V	300 V
Rated impulse voltage	6 kV	6 kV
Overtoltage category	III	III
Pollution severity	2	2
Clearances and creepage distances	≥ 5.5 mm	≥ 5.5 mm
Insulation coordination/dielectric strength I/O to TS	4 kV _{eff} / 1 min	4 kV _{eff} / 1 min
Opto-coupler	acc. to VDE 0884	acc. to VDE 0884
Ambient temperature rowed on mounting rail without clearances	-25 °C...+40 °C	-25 °C...+50 °C
Ambient temperature rowed with clearances ≥ 20 mm	-25 °C...+50 °C	-25 °C...+50 °C
Storage temperature	-40 °C...+60 °C	-40 °C...+85 °C
Conductor	AWG 22...12	AWG 22...12
Conductor cross-section	1.5 mm ²	1.5 mm ²
Approvals	CE, UL, CSA	CE, UL, CSA
Overall width	6 mm	6 mm
Accessories		
End plate	AP MCZ 1.5 8389030000	AP MCZ 1.5 8389030000
Further accessories, dimensions and connection data	Page 305	Page 305

Opto-coupler in component housing mini coupler DK

Opto-couplers DKO

- Coupling of digital sensor-/actuator-signals between PLC and process
- Low cost solution for level- and potential-equalization
- Low input power
- Screw clamp connection technology
- 6 mm width

DKO 5 Vdc

DKO 5 VTTL

DKO 12 Vdc

DKO 24 Vac/dc

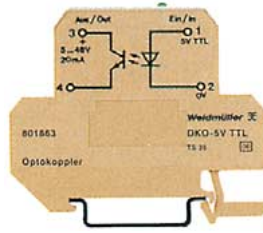

Schematic circuit diagram

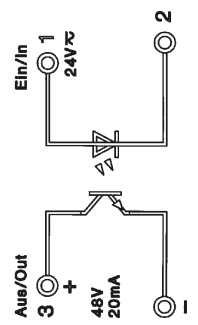
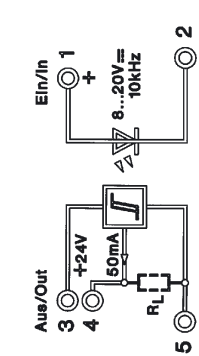
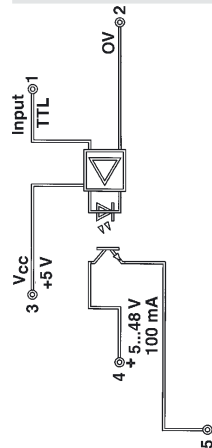
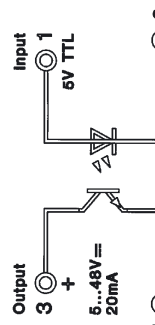
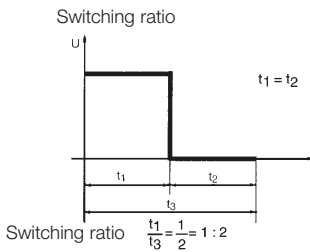

Ordering data	
For TS 32	Y
For TS 35	W
With combination foot TS 32/TS 35	

Technical data	
Input voltage	5 Vdc ±5 %
Switch-on voltage	2.4 Vdc
Input current	≤10 mA
Max. input power	50 mW
Output voltage	5...48 Vdc
Max. output current	20 mA
Min. output current	50 µA
Max. switching frequency; switching ratio 1: 2	20 Hz

Switch-on delay	≤15 µs
-----------------	--------

Switch-off delay	≤70 µs
------------------	--------

Voltage drop at max. load	≤1.6 V
---------------------------	--------

Insulation coordination to EN 50 178

Rated voltage	150 V
Rated impulse voltage	4 kV
Overvoltage category	IV
Pollution severity	2
Clearances and creepage distances	≥4 mm

Operating temperature	without clearances	-25 °C...+50 °C
	with clearances	-25 °C...+50 °C

Storage temperature	-40 °C...+85 °C
---------------------	-----------------

Conductor	AWG 22...12
-----------	-------------

Conductor cross-section	0.5...4 mm ²
-------------------------	-------------------------

Overall width	6 mm
---------------	------

Accessories	
End plate	AP DKT4 0687560000
Further accessories, dimensions and connection data	Page 305

Type	Cat. No.
DKO 5 Vdc	8018620000
DKO 5 Vdc	8018630000

Input: bottom	
Input voltage	5 VTTL
Input current	1 µA
Output voltage	5...48 Vdc
Max. output current	100 mA
Min. output current	50 µA
Max. switching frequency	3 kHz

Switch-on delay	approx.27 µs
-----------------	--------------

Switch-off delay	approx.35 µs
------------------	--------------

Voltage drop at max. load	≤1.6 V
---------------------------	--------

Rated voltage	300 V
Rated impulse voltage	6 kV
Overvoltage category	IV
Pollution severity	2
Clearances and creepage distances	≥5.5 mm

Operating temperature	-25 °C...+50 °C
	-25 °C...+50 °C

Storage temperature	-40 °C...+85 °C
---------------------	-----------------

Conductor	AWG 22...12
-----------	-------------

Conductor cross-section	0.5...4 mm ²
-------------------------	-------------------------

Overall width	6 mm
---------------	------

Type	Cat. No.
AP DK5	8268870000
Further accessories, dimensions and connection data	Page 305

Type	Cat. No.
DKO DK5 5 VTTL	8228650000

Input: bottom	
Input voltage	12 Vdc ±20 %
Switch-on voltage	approx.7 V
Input current	11 mA
Max. input power	130 mW
Output voltage	24 Vdc ±10 %
Max. output current	50 mA
Min. output current	50 µA
Max. switching frequency	10 kHz

Switch-on delay	1 µs
-----------------	------

Switch-off delay	2.5 µs
------------------	--------

Voltage drop at max. load	≤1 V
---------------------------	------

Rated voltage	300 V
Rated impulse voltage	6 kV
Overvoltage category	IV
Pollution severity	2
Clearances and creepage distances	≥5.5 mm

Operating temperature	-25 °C...+50 °C
	-25 °C...+50 °C

Storage temperature	-40 °C...+85 °C
---------------------	-----------------

Conductor	AWG 22...12
-----------	-------------

Conductor cross-section	0.5...4 mm ²
-------------------------	-------------------------

Overall width	12 mm
---------------	-------

Type	Cat. No.
AP DKT4	0687560000
Further accessories, dimensions and connection data	Page 305

Type	Cat. No.
DKO 12 Vdc	8184030000

Input: bottom	
Input voltage	24 Vac/dc ±10 %
Switch-on voltage	112.8 Vac/16.8 Vdc
Input current	11.4 mAac/9.6 mAdc
Max. input power	280 mVA/230 mW
Output voltage	5...48 Vdc
Max. output current	20 mA
Min. output current	50 µA
Max. switching frequency	ac: 5 Hz dc: 10 Hz

Switch-on delay	≤15 ms at dc
-----------------	--------------

Switch-off delay	≤25 ms at dc
------------------	--------------

Voltage drop at max. load	≤1 V
---------------------------	------

Rated voltage	300 V
Rated impulse voltage	4 kV
Overvoltage category	III
Pollution severity	2
Clearances and creepage distances	≥4 mm

Operating temperature	-25 °C...+40 °C
	-25 °C...+50 °C

Storage temperature	-40 °C...+85 °C
---------------------	-----------------

Conductor	AWG 22...12
-----------	-------------

Conductor cross-section	0.5...4 mm ²
-------------------------	-------------------------

Overall width	6 mm
---------------	------

Type	Cat. No.
AP DKT4	0687560000
Further accessories, dimensions and connection data	Page 305

Type	Cat. No.
DKO 24 Vac/dc	8008090000
DKO 24 Vac/dc	8008150000

Input: bottom	
Input voltage	24 Vac/dc ±10 %
Switch-on voltage	112.8 Vac/16.8 Vdc
Input current	11.4 mAac/9.6 mAdc
Max. input power	280 mVA/230 mW
Output voltage	5...48 Vdc
Max. output current	20 mA
Min. output current	50 µA
Max. switching frequency	ac: 5 Hz dc: 10 Hz

Switch-on delay	≤15 ms at dc
-----------------	--------------

Switch-off delay	≤25 ms at dc
------------------	--------------

Voltage drop at max. load	≤1 V
---------------------------	------

Rated voltage	300 V
Rated impulse voltage	4 kV
Overvoltage category	III
Pollution severity	2
Clearances and creepage distances	≥4 mm

Operating temperature	-25 °C...+40 °C
	-25 °C...+50 °C

Storage temperature	-40 °C...+85 °C
---------------------	-----------------

Conductor	AWG 22...12
-----------	-------------

Conductor cross-section	0.5...4 mm ²
-------------------------	-------------------------

Overall width	6 mm
---------------	------

Type	Cat. No.
AP DKT4	0687560000
Further accessories, dimensions and connection data	Page 305

Opto-coupler in component housing mini coupler DK

Opto-couplers DKO

DKO 24 Vdc

DKO 24 Vdc

DKO 24 Vdc

DKO 24 Vdc

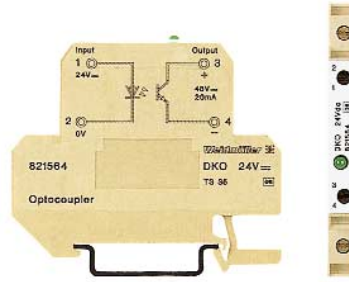

Schematic circuit diagram

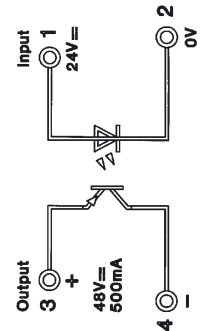
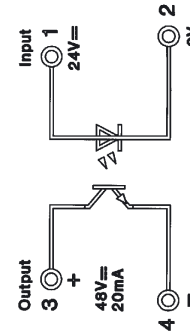
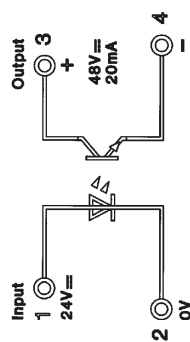
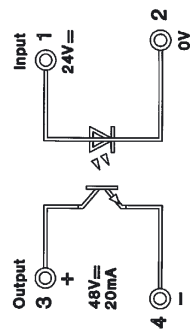
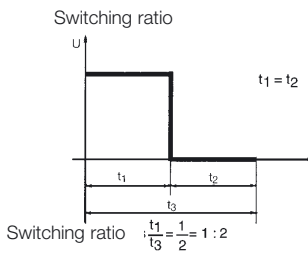

Ordering data	
For TS 32	Y
For TS 35	W

Technical data	
Input voltage	24 Vdc ±10 %
Switch-on voltage	approx. 19 V/7.5 mA
Input current	≤15 mA
Max. input power	360 mW
Output voltage	5...48 Vdc
Max. output current	20 mA
Min. output current	50 µA
Max. switching frequency; switching ratio 1: 2	3 kHz

Switch-on delay	approx. 50 µs
-----------------	---------------

Switch-off delay	approx. 80 µs
------------------	---------------

Voltage drop at max. load	≤900 mV
---------------------------	---------

Insulation coordination to EN 50 178

Rated voltage	300 V
Rated impulse voltage	4 kV
Overvoltage category	II
Pollution severity	2
Clearances and creepage distances	≥4 mm
Operating temperature	without clearances: -25 °C...+40 °C with clearances: -25 °C...+50 °C
Storage temperature	-40 °C...+85 °C
Conductor	AWG 22...12
Conductor cross-section	0.5...4 mm ²
Overall width	6 mm

Accessories	
End plate	AP DKT4 0687560000
Further accessories, dimensions and connection data	Page 305

Type	Cat. No.
DKO 24 Vdc	8028300000

Input: top	
Input voltage	24 Vdc ±10 %
Switch-on voltage	approx. 19 V/7.5 mA
Input current	≤15 mA
Max. input power	360 mW
Output voltage	5...48 Vdc
Max. output current	20 mA
Min. output current	50 µA
Max. switching frequency; switching ratio 1: 2	3 kHz

Switch-on delay	approx. 50 µs
-----------------	---------------

Switch-off delay	approx. 80 µs
------------------	---------------

Voltage drop at max. load	≤900 mV
---------------------------	---------

Insulation coordination to EN 50 178

Rated voltage	300 V
Rated impulse voltage	4 kV
Overvoltage category	II
Pollution severity	2
Clearances and creepage distances	≥4 mm
Operating temperature	-25 °C...+40 °C
Storage temperature	-40 °C...+85 °C
Conductor	AWG 22...12
Conductor cross-section	0.5...4 mm ²
Overall width	6 mm

Type	Cat. No.
DKO 24 Vdc	8215640000

Type	Cat. No.
DKO 24 Vdc	8215640000

Input: bottom	
Input voltage	24 Vdc ±10 %
Switch-on voltage	approx. 19 V/7.5 mA
Input current	≤15 mA
Max. input power	360 mW
Output voltage	5...48 Vdc
Max. output current	20 mA
Min. output current	50 µA
Max. switching frequency; switching ratio 1: 2	3 kHz

Switch-on delay	approx. 50 µs
-----------------	---------------

Switch-off delay	approx. 80 µs
------------------	---------------

Voltage drop at max. load	≤900 mV
---------------------------	---------

Insulation coordination to EN 50 178

Rated voltage	300 V
Rated impulse voltage	4 kV
Overvoltage category	III
Pollution severity	2
Clearances and creepage distances	≥4 mm
Operating temperature	-25 °C...+40 °C
Storage temperature	-40 °C...+85 °C
Conductor	AWG 22...12
Conductor cross-section	0.5...4 mm ²
Overall width	6 mm

Type	Cat. No.
DKO 24 Vdc	8248790000

Type	Cat. No.
DKO 24 Vdc	8248790000

Input: bottom	
Input voltage	24 Vdc ±10 %
Switch-on voltage	approx. 19 V/7.5 mA
Input current	≤8.5 mA
Max. input power	204 mW
Output voltage	5...48 Vdc
Max. output current	20 mA
Min. output current	50 µA
Max. switching frequency; switching ratio 1: 2	3 kHz

Switch-on delay	approx. 50 µs
-----------------	---------------

Switch-off delay	approx. 80 µs
------------------	---------------

Voltage drop at max. load	≤900 mV
---------------------------	---------

Insulation coordination to EN 50 178

Rated voltage	300 V
Rated impulse voltage	4 kV
Overvoltage category	III
Pollution severity	2
Clearances and creepage distances	≥4 mm
Operating temperature	-25 °C...+40 °C
Storage temperature	-40 °C...+85 °C
Conductor	AWG 22...12
Conductor cross-section	0.5...4 mm ²
Overall width	6 mm

Type	Cat. No.
DKO 24 Vdc	8019580000

Type	Cat. No.
DKO 24 Vdc	8019580000

Input: bottom	
Input voltage	24 Vdc ±10 %
Switch-on voltage	approx. 17 V
Input current	6 mA
Max. input power	145 mW
Output voltage	5...48 Vdc
Max. output current	500 mA
Min. output current	50 µA
Max. switching frequency; switching ratio 1: 2	200 Hz

Switch-on delay	approx. 40 µs
-----------------	---------------

Switch-off delay	approx. 65 µs
------------------	---------------

Voltage drop at max. load	≤800 mV
---------------------------	---------

Insulation coordination to EN 50 178

Rated voltage	300 V
Rated impulse voltage	4 kV
Overvoltage category	II
Pollution severity	2
Clearances and creepage distances	≥4 mm
Operating temperature	-25 °C...+40 °C
Storage temperature	-40 °C...+85 °C
Conductor	AWG 22...12
Conductor cross-section	0.5...4 mm ²
Overall width	6 mm

Type	Cat. No.
DKO 24 Vdc	8019590000

Opto-coupler in component housing mini coupler DK

Opto-couplers DKO

- Coupling of digital sensor-/actuator-signals between PLC and process
- Low cost solution for level- and potential-equalization
- Low input power
- Screw clamp connection technology
- 6 mm width

DKO 24 Vdc

DKO 24 Vdc

DKO 24 Vdc

DKO 24 Vac/dc

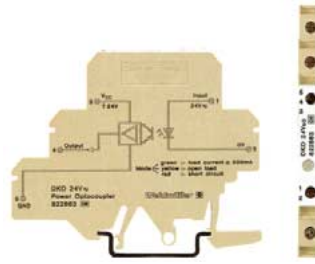

Schematic circuit diagram

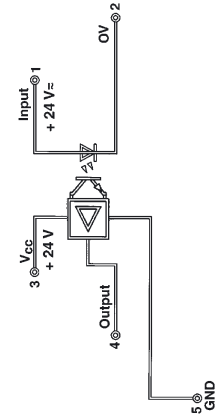
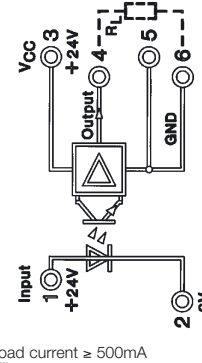
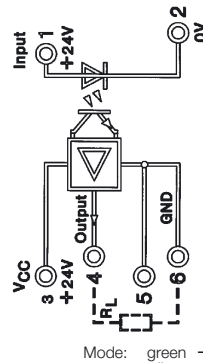
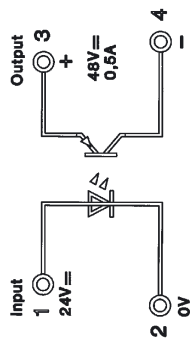
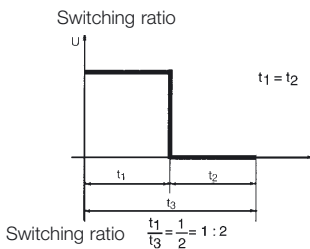

Mode: green → Load current ≥ 500mA
 yellow → Idling
 red → Short circuit

Ordering data

For TS 32	Y
For TS 35	W

With combination foot TS 32 / TS 35

Technical data

Input voltage	24 Vdc ±10 %
Switch-on voltage	approx.17 Vdc
Input current	6 mA
Max. input power	145 mW
Output voltage	5...48 Vdc
Max. output current	500 mA
Min. output current	50 µA
Max. switching frequency; switching ratio 1: 2	200 Hz
Switch-on delay	approx.40 µs
Switch-off delay	approx.65 µs
Voltage drop at max. load	≤800 mV

Insulation coordination to EN 50 178

Rated voltage	300 V
Rated impulse voltage	4 kV
Overvoltage category	III
Pollution severity	2
Clearances and creepage distances	≥4 mm
Operating temperature	without clearances: -25 °C...+40 °C with clearances: -25 °C...+50 °C
Storage temperature	-40 °C...+85 °C
Conductor	AWG 22...12
Conductor cross-section	0.5...4 mm ²
Overall width	6 mm

Accessories

End plate	AP DKT4	0687560000
Further accessories, dimensions and connection data	Page 305	

Type Cat. No.

DKO 24 Vdc **8215630000**

Type Cat. No.

DKO 24 Vdc **8181990000**

Type Cat. No.

DKO 24 Vdc **8215600000**

Type Cat. No.

DKO 24 Vac/dc **8228630000**

Input: bottom

Input voltage	24 Vdc ±10 %
Switch-on voltage	approx.16 Vac/dc
Input current	13 mAac/12 mAdc
Max. input power	220 mVA/195 mW
Output voltage	24 Vdc ±20 %
Max. output current	2 A
Switching frequency	ac: 10 Hz dc: ≤30 Hz
Switch-on delay	2 ms
Switch-off delay	7 ms

Input: top

Input voltage	24 Vdc ±10 %
Switch-on voltage	approx.18 Vdc
Input current	12 mA
Max. input power	290 mW
Output voltage	24 Vdc ±10 %
Max. output current	2 A
Switching frequency	100 Hz

Input: top

Input voltage	24 Vdc ±10 %
Switch-on voltage	approx.18 Vdc
Input current	12 mA
Max. input power	290 mW
Output voltage	24 Vdc ±10 %
Max. output current	2 A
Switching frequency	100 Hz

Opto-coupler in component housing mini coupler DK

Opto-couplers DKO

DKO DK5 24 Vdc

DKO 115 Vac/dc

DKO 230 Vac/dc

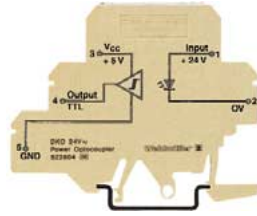

Schematic circuit diagram

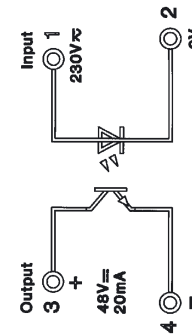
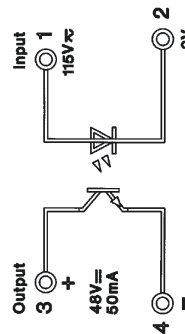
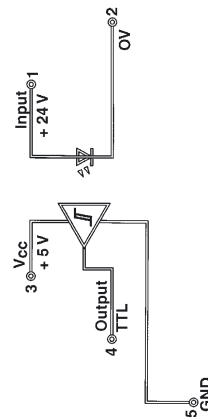
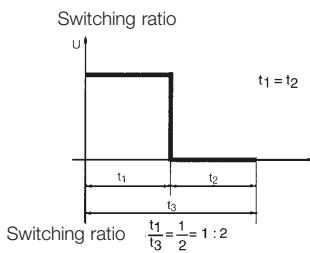

Ordering data	
For TS 32	Y
For TS 35	W
With combination foot TS 32/TS 35	

Technical data	
Input voltage	24 Vdc ±20 %
Switch-on voltage	approx.17 Vdc
Input current	4.7 mA
Max. input power	112 mW
Output voltage	5 VTTL
Max. output current	8 mA, Fan Out = 20 LS-TTL
Min. output current	
Max. switching frequency; switching ratio 1: 2	100 kHz 1:2/50 kHz 1:10

Switch-on delay	1 µs
-----------------	------

Switch-off delay	2.5 µs
------------------	--------

Voltage drop at max. load	
---------------------------	--

Insulation coordination to EN 50 178

Rated voltage	300 V
Rated impulse voltage	4 kV
Overvoltage category	III
Pollution severity	2
Clearances and creepage distances	≥5.5 mm
Operating temperature	without clearances with clearances
	-25 °C...+40 °C -25 °C...+50 °C
Storage temperature	-25 °C...+85 °C
Conductor	AWG 22...12
Conductor cross-section	0.5...4mm ²
Overall width	6 mm

Accessories	
End plate	AP DK5 8268870000
Further accessories, dimensions and connection data	Page 305

Type	Cat. No.
DKO 24 Vdc	8228640000

Input: top	
Input: bottom	115 Vac/dc +5 % -15 %
	approx.65 Vac/approx.66 Vdc
	2.65 mAac/3 mAac
	390 mVA/350 mW
	5...48 Vdc
	50 mA
	ac: 5 Hz/dc: 20 Hz

Switch-on delay	17.4 ms
-----------------	---------

Switch-off delay	27.4 ms
------------------	---------

Voltage drop at max. load	<1.6 V
---------------------------	--------

Rated voltage	300 V
Rated impulse voltage	6 kV
Overvoltage category	IV
Pollution severity	2
Clearances and creepage distances	≥5.5 mm
Operating temperature	without clearances with clearances
	-25 °C...+40 °C -25 °C...+50 °C
Storage temperature	-40 °C...+85 °C
Conductor	AWG 22...12
Conductor cross-section	0.5...4 mm ²
Overall width	6 mm

Type	Cat. No.
DKO 115 Vac/dc	8027980000
DKO 115 Vac/dc	8077860000

Type	Cat. No.
DKO 115 Vac/dc	8027980000
DKO 115 Vac/dc	8077860000

Input: bottom	
Input: bottom	230 Vac/dc +5 % -15 %
	approx.130 Vac/approx.140 Vdc
	1.8 mAac/1.7 mAac
	395 mVA/370 mW
	5...48 Vdc
	20 mA
	50 µA
	ac: 5 Hz/dc: 20 Hz

Switch-on delay	20 ms
-----------------	-------

Switch-off delay	20 ms
------------------	-------

Voltage drop at max. load	<1.6 V
---------------------------	--------

Rated voltage	300 V
Rated impulse voltage	4 kV
Overvoltage category	III
Pollution severity	2
Clearances and creepage distances	≥3 mm
Operating temperature	without clearances with clearances
	-25 °C...+50 °C -25 °C...+50 °C
Storage temperature	-40 °C...+85 °C
Conductor	AWG 22...12
Conductor cross-section	0.5...4 mm ²
Overall width	6 mm

Type	Cat. No.
DKO 230 Vac/dc	8008100000
DKO 230 Vac/dc	8008160000

Type	Cat. No.
DKO 230 Vac/dc	8008100000
DKO 230 Vac/dc	8008160000

Input: bottom	
Input: bottom	230 Vac/dc +5 % -15 %
	approx.130 Vac/approx.140 Vdc
	1.8 mAac/1.7 mAac
	395 mVA/370 mW
	5...48 Vdc
	20 mA
	50 µA
	ac: 5 Hz/dc: 20 Hz

Switch-on delay	20 ms
-----------------	-------

Switch-off delay	20 ms
------------------	-------

Voltage drop at max. load	<1.6 V
---------------------------	--------

Rated voltage	300 V
Rated impulse voltage	4 kV
Overvoltage category	III
Pollution severity	2
Clearances and creepage distances	≥3 mm
Operating temperature	without clearances with clearances
	-25 °C...+50 °C -25 °C...+50 °C
Storage temperature	-40 °C...+85 °C
Conductor	AWG 22...12
Conductor cross-section	0.5...4 mm ²
Overall width	6 mm

Type	Cat. No.
AP DK5	8268870000
AP DKT4	0687560000
Page 305	

Type	Cat. No.
AP DKT4	0687560000
Page 305	

Opto-coupler in component housing mini coupler DK

Opto-couplers DKO

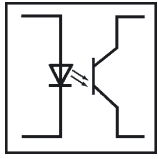

DKO 35 48 Vdc

DKO 35 60 Vdc

DKO 35 125 Vdc

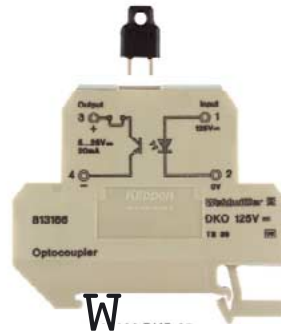

Schematic circuit diagram

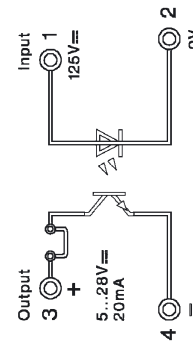
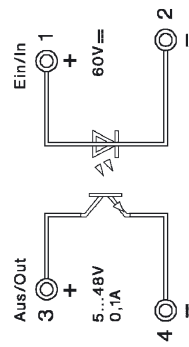
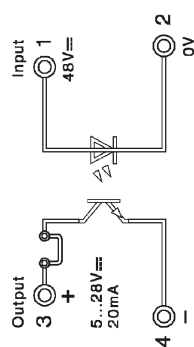

Ordering data

For TS 32	Y
For TS 35	W

With combination foot TS 32 / TS 35

Technical data

Input voltage	48 Vdc $\pm 10\%$
Input current	3.7 mA $\pm 20\%$
Input nominal power	178 mW
Total power loss	400 mW
Making threshold	approx. 32 Vdc
Input reverse voltage	max. 1 kV
Output voltage	5...28 Vdc
Output current	max. 20 mA
Voltage drop at max. load	1.6 V
Feature of output circuit	Disconnection plug
Indication	LED red
Dielectric strength input/output	3.75 kV _{eff} / 5.3 kVdc
Dielectric strength to mounting rail	4 kV _{eff}
Clearances and creepage distances	>5 mm
Operating temperature	-25 °C...+50 °C
Storage temperature	-40 °C...+60 °C
Conductor	AWG 22...12
Conductor cross-section	0.5...4 mm ²
Overall width	6 mm

Type	Cat. No.
DKO 35 48 Vdc	8151230000

Type	Cat. No.
DKO 35 60 Vdc	8067100000

Type	Cat. No.
DKO 35 125 Vdc	8131660000

Input voltage	60 Vdc $\pm 10\%$
Input current	5.6 mA $\pm 20\%$
Input nominal power	340 mW
Total power loss	420 mW
Making threshold	approx. 42 Vdc / 5.3 mA
Input reverse voltage	max. 1 kV
Output voltage	5...48 Vdc
Output current	max. 100 mA
Voltage drop at max. load	0.8 V
Feature of output circuit	
Indication	LED green
Dielectric strength input/output	3.75 kV _{eff} / 5.3 kVdc
Dielectric strength to mounting rail	4 kV _{eff}
Clearances and creepage distances	>4 mm
Operating temperature	-25 °C...+50 °C
Storage temperature	-40 °C...+60 °C
Conductor	AWG 22...12
Conductor cross-section	0.5...4 mm ²
Overall width	6 mm

Input voltage	125 Vdc $\pm 10\%$
Input current	1.7 mA $\pm 20\%$
Input nominal power	215 mW
Total power loss	400 mW
Making threshold	approx. 80 Vdc
Input reverse voltage	max. 1 kV
Output voltage	5...28 Vdc
Output current	max. 20 mA
Voltage drop at max. load	1.6 V
Feature of output circuit	Disconnection plug
Indication	LED red
Dielectric strength input/output	3.75 kV _{eff} / 5.3 kVdc
Dielectric strength to mounting rail	4 kV _{eff}
Clearances and creepage distances	>5 mm
Operating temperature	-25 °C...+50 °C
Storage temperature	-40 °C...+60 °C
Conductor	AWG 22...12
Conductor cross-section	0.5...4 mm ²
Overall width	6 mm

Type	Cat. No.
AP DKT4	0687560000

Accessories

End plate	AP DKT4	0687560000
-----------	---------	-------------------

Type	Cat. No.
AP DKT4	0687560000

Type	Cat. No.
AP DKT4	0687560000

Type	Cat. No.
AP DKT4	0687560000

Opto-coupler in component housing mini coupler DK

Opto-couplers DKO S0 signal sensor

Application example:
Signals for consumers are normally transferred via an interface. Generally, this interface must conform with DIN 43867 (interface for signal transmission). There must be a differentiation between the passive interface and active S0 interface. The actual signals, that are correspondingly proportional to the relevant consumption (electrical energy, gas consumption, water, district heating, etc.) are shown at measuring sensors (electric meter, etc.) The interface itself is purely passive (acceptor) and must be supplied via a source. The source for providing the current is built into the active interface. The following threshold values are specified:

$$I_{\max} = 27 \text{ mAdc}$$

$$U_{\max} = 27 \text{ Vdc}$$

$$f_{\max} = 16.66 \text{ Hz}$$

For the recognition of the corresponding consumption signals, the following currents are integrated:

$$\text{ON (active)} \rightarrow 10 \dots 27 \text{ mA}$$

$$\text{Off (inactive)} \rightarrow 0 \dots 2 \text{ mA}$$

The module accepts the input from the signal sensor and outputs the opto-decoupled output signal, i. e. galvanically isolated.

DKO switching amplifiers/opto-couplers for Namur initiators

DKO DK4 S0

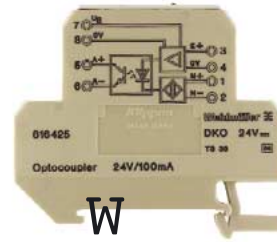

DKO

Schematic circuit diagram

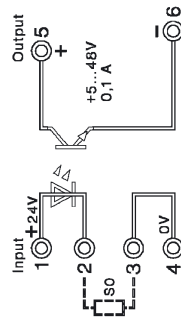

Schematic circuit diagram

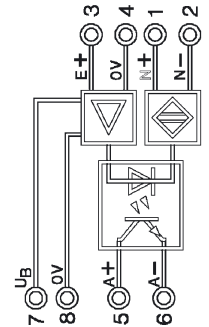

Ordering data	
For TS 32	y
For TS 35	w

With combination foot TS 32 / TS 35

Technical data	
Input	
Input voltage	24 Vdc ±10 %
Input current	≤13 mA
Pulse generator	Specification acc. to DIN 43864 (current interface for connection to pulse generator acc. to DIN 43864)
Output	
Output voltage	5...48 Vdc
Output current	max. 100 mA
Voltage proof input-output/mounting rail	4 kV _{eff}

Insulation coordination to DIN VDE 0160, Draft 11/94	
Rated voltage	300 V
Rated impulse voltage	6 kV
Overvoltage category	IV
Pollution severity	2
Clearances and creepage distances	≥5.5 mm

Operating temperature	without clearances	-25 °C...+40 °C
	with clearances	-25 °C...+50 °C
Storage temperature		-40 °C...+60 °C
Conductor		AWG 22...12
Conductor cross-section		0.5...4 mm ²
Overall width		12 mm

Accessories	
End plate	AP DKT4 0687560000

Type	Cat. No.
DKO DK4 S0	8467030000
DKO DK4 S0	8100180000

Ordering data	
For TS 32	y
For TS 35	w

With combination foot TS 32 / TS 35

Technical data		
Input		
Input voltage	24 Vdc ±20 %	
Input current	≤35 mA	
Reverse polarity protection	up to 1 kV available	
NAMUR-Input (N+ and N-)		
Switching frequency	300 Hz f, pulse duty factor 1:1	
Switch-on delay	approx.45 µs	
Switch-off delay	approx.450 µs	
Input (E+ and 0)		
Switch-on point	approx.18 V	
Switch off-point	ca 15 V	
Current consumption	< 5 mA	
Max. switching frequency	300 Hz f, pulse duty factor 1:1	
Switch-on delay	approx.20µs	
Switch-off delay	approx.400 µs	
Output (A+ and A-)		
Output voltage	5...30 Vdc	
Output current	max. 100 mA	
Switching capacity	max. 3 W	
Internal voltage drop	max. 1 V	
Protective measure	Free-wheel. diode btwn. A+...A-	
Voltage proof input-output/mounting rail	4 kV _{eff}	
Operating temperature	without clearances	-25 °C...+40 °C
	with clearances	-25 °C...+50 °C
Storage temperature		-40 °C...+60 °C
Conductor		AWG 22...12
Conductor cross-section		0.5...4 mm ²
Overall width		12 mm

Accessories	
End plate	AP DKT4 0687560000

Type	Cat. No.
DKO	8164250000

Opto-coupler in component housing EG

Opto-couplers EGO

EGO 1 5 V

For low voltage
alternatively positive
or negative switching

EGO 1 5 V

EGO 1 12 V

EGO 1 24 V



Schematic circuit diagram

Switching ratio

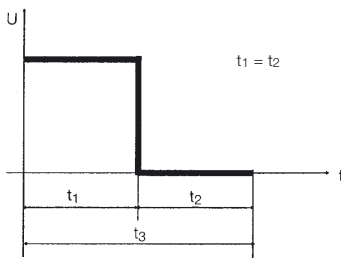

Switching ratio $\frac{t_1}{t_3} = \frac{1}{2} = 1 : 2$

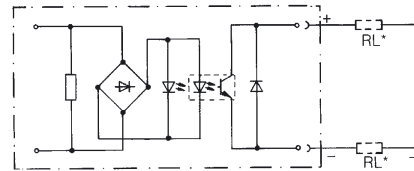

* Wiring option

Ordering data

Type	Cat. No.	Type	Cat. No.	Type	Cat. No.	Type	Cat. No.
EGO 1, 5 V	0266160000	EGO 1, 12 V	8011250000³⁾	EGO 1, 12 V	0114260000	EGO 1, 24 V	0558160000

Rated data

Input voltage	3...5 V- ²⁾	3...12 V-	12 V0, ±10 %	24 V-, ±10 %
Rated consumption - (W)	9...45 mW	30...280 mW	0.35 W	0.6 W
Rated consumption ~ (VA)	-	-	0.45 VA	-
Output supply voltage	5...48 V- ¹⁾	5...48 V- ¹⁾	5...48 V- ¹⁾	5...48 V- ¹⁾
Voltage drop at max. load current	<1 V	<1 V	<1.6 V	<1 V
Output current	20 mA	20 mA	100 mA	20 mA

Derating curve
a = mounted on rail without clearance

b = mounted on rail without clearance ≥ 20 mm

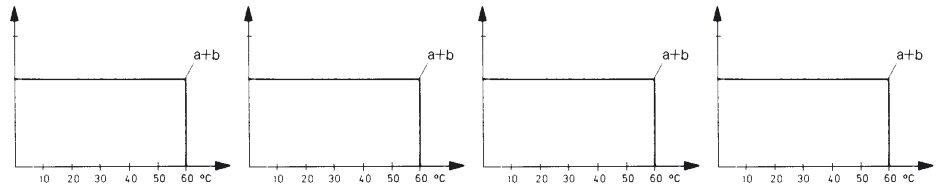
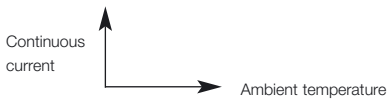

Impulse loading, max. current (not periodic)	0.2 A/10 ms	0.2 A/10 ms	0.8 A/10 ms	0.2 A/10 ms
Max. reverse current (quiescent current) at U = 48 V	0.16 mA	0.16 mA	0.16 mA	0.16 mA
Switch-on time (cyclic operation)	≤12 μs	22 μs	≤6 ms	≤30 μs
Switching-off time (cyclic operation)	≤180 μs	44 μs	≤13 ms	≤100 μs
Max. switching frequency, DC	100 Hz	5000 Hz/5000 Hz	20 Hz	3000 Hz
Max. switching frequency, AC			<10 Hz	
Switching ratio	1 : 2	1 : 2/1 : 4	1 : 2	1 : 2
Min. input impulse width	50 μs	50 μs		
Storage temperature	-40 °C...+60 °C	-40 °C...+85 °C	-40 °C...+85 °C	-40 °C...+85 °C
Ambient temperature				
- , rowed on mounting rail without clearances	-25 °C...+60 °C	-25 °C...+60 °C	-25 °C...+60 °C	-25 °C...+60 °C
- , rowed with clearances ≥ 20 mm	-25 °C...+60 °C	-25 °C...+60 °C	-25 °C...+60 °C	-25 °C...+60 °C
Insulation coordination to EN 50 178				
Overvoltage category	III	III	III	III
Pollution severity	2	2	2	2
Accessories, dimensions and connection data see	Page 306, Fig. I	Page 306, Fig. I	Page 306, Fig. I	Page 306, Fig. I

¹⁾ Not TTL-compatible

²⁾ Conditionally level-compatible

³⁾ At Ue ≤ 5 V, the LED only lights weakly or not at all. Output switching function is not affected.

Opto-coupler in component housing EG

EGO 1 24 V



EGO 2 115 V₀
for low voltage



EGO 2 230 V₀

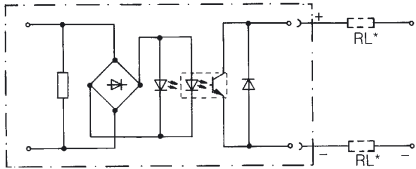

* Wiring option

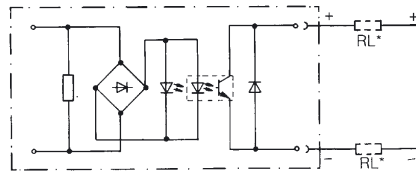

In the case of inductive or capacitive electrical noise, it is recommended to connect an RC network (DK 4 RC) upstream or to use EGO 3.

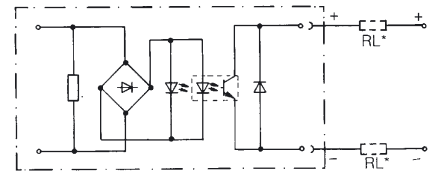

Type	Cat. No.
EGO 1, 24 V	0609860000
24 V₀, ±10 %	
0.5 W	
0.6 VA	
5...48 V ⁻¹	
<1.6 V	
100 mA	

Type	Cat. No.
EGO 2, 115 V ₀	0131860000
117 V₀, ±10 %	
0.8 W	
0.9 VA	
5...48 V ⁻¹	
<1.6 V	
100 mA	

Type	Cat. No.
EGO 2, 230 V ₀	0546360000
230 V₀, +5 %-15 %	
1.2 W	
1.4 VA	
5...48 V ⁻¹	
<1.6 V	
100 mA	

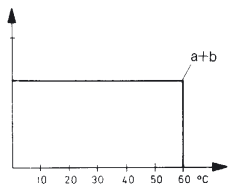

0.8 A/10 ms	
0.16 mA	
≤ 2 ms	
≤ 15 ms	
20 Hz	
<10 Hz	
1 : 2	
-40 °C...+85 °C	
-25 °C...+60 °C	
-25 °C...+60 °C	
III	
2	
Page 306, Fig. I	

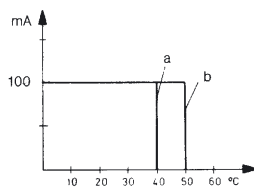

0.8 A/10 ms	
0.16 mA	
≤ 5 ms	
≤ 22 ms	
20 Hz	
< 10 Hz	
1 : 2	
-40 °C...+85 °C	
-25 °C...+40 °C	
-25 °C...+50 °C	
III	
2	
Page 306, Fig. I	

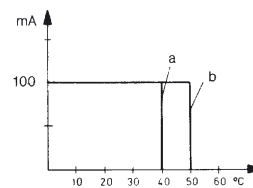

0.8 A/10 ms	
0.16 mA	
≤ 13 ms	
≤ 10 ms	
20 Hz	
< 10 Hz	
1 : 2	
-40 °C...+85 °C	
-25 °C...+40 °C	
-25 °C...+50 °C	
III	
2	
Page 306, Fig. I	

Opto-coupler in component housing WAVESERIES

Opto-couplers WAVESERIES

Opto-coupler in WAVEBOX:

- Independent connection technology
 - pluggable connection unit optionally available with screw or tension clamp connection technology
- Fast commissioning and after-sales service
 - pluggable replacement PCBs
- Save wiring
 - cross-connection option at input / output
- Fast switching
 - high frequency output, up to 100 kHz
- Reliable power output
 - short-circuit and overload proof
- Space-saving components
 - 4-channel opto-couplers

WOS 1 5 VDC negative switching



WOS 1 3.5-15 VDC



WOS 1 12 VDC



WOS 1 15-60 VDC



Schematic circuit diagram

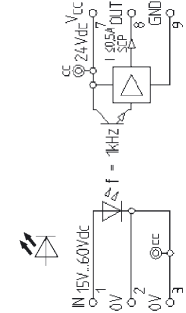
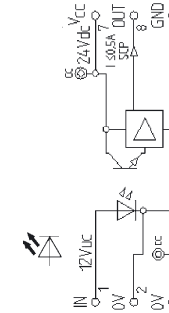
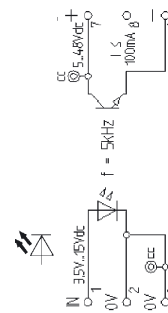
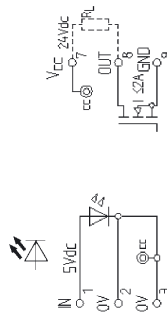

Ordering data	Type	Cat. No.	Type	Cat. No.	Type	Cat. No.	Type	Cat. No.
Screw connection	WOS 1 5 Vdc	8275430000	WOS 1 3.5-15 Vdc	8275390000	WOS 1 12 Vdc	8275500000	WOS 1 15-60 Vdc	8237730000
Tension clamp connection	WOZ 1	8430030000	WOZ 1	8430040000	WOZ 1	8429990000	WOZ 1	8430090000
Input								
Input voltage	4.0 Vdc... 5 Vdc ...6.0 Vdc		3.5 Vdc...15 Vdc		10 Vdc... 12 Vdc ...14 Vdc		15 Vdc...60 Vdc ¹⁾	
Input current	7.5 mA at 4.0 V 13.5 mA at 5.0 V 19.0 mA at 6.0 V		10.5 mA at 3.5.0 V 12.5 mA at 5.0 V 25.0 mA at 15 V		15.3 mA ac at 12 V 12.4 mA dc at 12 V		1.4 mA at 15 V 2.5 mA at 24 V 4.1 mA at 48 V ...60 V	
Making threshold	approx.2.2 V		approx.2.5 V		approx.8 V		ca.12 V	
Breaking threshold	approx.2.0 V		approx.1.5 V		approx.7 V		approx.9 V	
Input frequency	100 Hz		5 kHz				1 kHz	
Switch-on delay	100 us		8 us		10 ms ac and 4 ms dc		90 us	
Switch-off delay	1 ms		35 us		20 ms ac and 18 ms dc		250 us	
Status indicator	LED green in input		LED green in input		LED green in output		LED green in output	
Output	negative switching				short-circuit protection		short-circuit protection	
Output current range					10 mA...0.6 A		10 mA A...0.6 A	
Nominal output current	max. 2 A*		max. 100 mA		max. 500 mA		max. 500 mA	
Output voltage	18 Vdc... 24 Vdc ...30 Vdc		5 Vdc...48 Vdc		12 Vdc... 24 Vdc ...28 Vdc		12 Vdc... 24 Vdc ...28 Vdc	
Response threshold					typ. 0.7 A ... 1.8 A min. 0.7 A; max. 2.4 A		typ. 0.7 A ... 1.8 A min.0.7 A; max. 2.4 A	
Residual voltage	≤ 300 mV		≤ 1.5 V at 100 mA		≤ 0.5 V, at 500 mA		≤ 0.5 V at 500 mA	
Protection circuit	Varistor		Varistor, integr. free-wh. diode		Polarity protection, varistor		Polarity protection, varistor	
Voltage supply					12Vdc... 24Vdc ...28Vdc		12 Vdc... 24 Vdc ...28 Vdc	
Short-circuit in output	no		no		yes / max. 96 h		yes / max. 96 h	
Temperature								
Operating temperature**	-25 °C...+50 °C rowed		-25 °C...+60 °C rowed		-25 °C...+60 °C rowed		-25 °C...+60 °C rowed	
Storage temperature	-40 °C...+85 °C		-40 °C...+85 °C		-40 °C...+85 °C		-40 °C...+85 °C	
Mechanical data								
Overall width	22.5 mm		22.5 mm		22.5 mm		22.5 mm	
Housing material	Polyamide PA 66		Polyamide PA 66		Polyamide PA 66		Polyamide PA 66	
Approvals	UL/CSA		UL/CSA		UL/CSA		UL/CSA	
Reliable separation according to EN 50 178								
Coordination of insulation according to EN 50 178								
Opto-coupler according to VDE 0884								
Rated voltage	300 V		300 V		300 V		300 V	
Rated impulse voltage	4 kV		4 kV		4 kV		4 kV	
Overvoltage category	III		III		III		III	
Pollution severity	2		2		2		2	
Clearance/creepage path	≥ 5.5 mm		≥ 5.5 mm		≥ 5.5 mm		≥ 5.5 mm	
Accessories, dimensions and connection data see	Page 298 + 308		Page 298 + 308		Page 298 + 308		Page 298 + 308	

* at ambient temperature 20 °C/horizontal installation

¹⁾ **Caution:** Cross-connections may only be used for voltages ≤ 50 Vdc (extra-low voltage).

Opto-coupler in component housing WAVESERIES

Opto-couplers WAVESERIES

WOS 1 115 VUC

WOS 1 230 VUC



Schematic circuit diagram

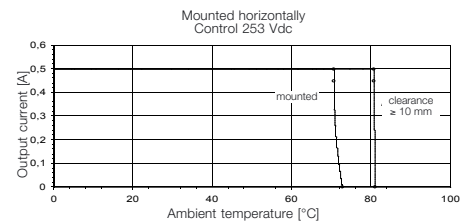
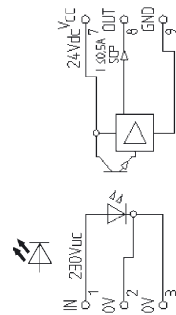
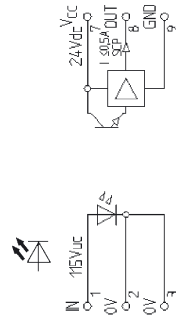

WOS 1 230 VUC • 8275380000

Ordering data

Screw connection

Tension clamp connection

Type	Cat. No.
WOS 1 115 Vuc	8235180000
WOZ 1	8430100000

Type	Cat. No.
WOS 1 230 Vuc	8275380000
WOZ 1	8430050000

Input

Input voltage

Input current

Making threshold

Breaking threshold

Input frequency

Switch-on delay

Switch-off delay

Status indicator

115 Vuc, max. 130 Vuc

3.1 mA **ac** at 115 V

2.9 mA **dc** at 115 V

ca.75 V **ac** and 71 **dc**

ca.70 Vuc

-

10 ms **ac** 10 ms **dc**

15 ms **ac** 15 ms **dc**

LED green in output

230 V, max. 250 Vuc

11.5 mA **ac** at 230 V

1.8 mA **dc** at 230 V

ca.170 V **ac** and 140 V **dc**

ca.130 V **ac** and 135 V **dc**

-

25 ms **ac** 15 ms **dc**

25 ms **ac** 20 ms **dc**

LED green in output

Output

Output current range

Nominal output current

Output voltage

Response threshold

Residual voltage

Protection circuit

Voltage supply

Short-circuit in output

short-circuit protection

10 mA...0.6 A

max. 500 mA

12 Vdc...**24 Vdc**...28 Vdc

typ. 0.7 A ... 1.8 A

min.0.7 A; max. 2.4 A

≤ 0.5 V at 500 mA

Polarity protection, varistor

12 Vdc...**24 Vdc**...28 Vdc

yes / max. 96 h

short-circuit protection

10 mA...0.6 A

max. 500 mA

12 Vdc...**24 Vdc**...28 Vdc

typ. 0.7 A ... 1.8 A

min.0.7 A; max. 2.4 A

≤ 0.5 V at 500 mA

Polarity protection, varistor

12 Vdc...**24 Vdc**...28 Vdc

yes / max. 96 h

Temperature

Operating temperature**

Storage temperature

-25 °C...+60 °C rowed

-40 °C...+85 °C

-25 °C...+60 °C rowed

-40 °C...+85 °C

Mechanical data

Overall width

Housing material

Approvals

Reliable separation according to EN 50 178

Coordination of insulation according to EN 50 178

Opto-coupler according to VDE 0884

Rated voltage

Rated impulse voltage

Overvoltage category

Pollution severity

Clearance/creepage path

22.5 mm

Polyamide PA 66

UL/CSA

300 V

4 kV

III

2

≥ 5.5 mm

22.5 mm

Polyamide PA 66

UL/CSA

300 V

4 kV

III

2

≥ 5.5 mm

Accessories, dimensions and connection data see

* at ambient temperature 20 °C/horizontal installation

Page 298 + 308

Page 298 + 308

Opto-coupler in component housing WAVESERIES

Opto-couplers WAVESERIES

with power output
(short-circuit proof and overload proof)

WOS 2 24 VUC

WOS 2 115 VUC

WOS 2 230 VUC

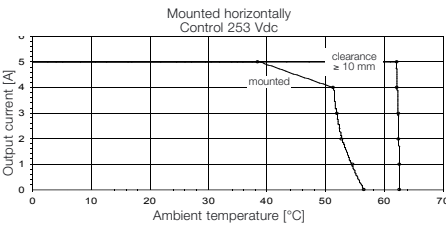

WOS 2 230 VUC • 8275220000

Schematic circuit diagram

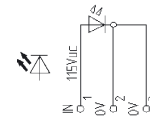
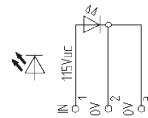
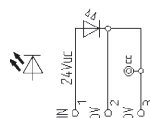
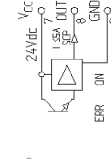
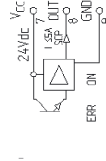
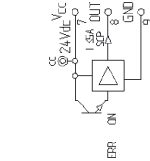

Ordering data

Screw connection

Tension clamp connection

Input

Input voltage

Input current

Making threshold

Breaking threshold

Switch-on delay

Switch-off delay

Status indicator normal operation

Status indicator short-circuit, underload, overload

Underload

Output

Output current

Closed supply-circuit current (output not switched)

Voltage supply

Residual voltage

Protection circuit

Short-circuit in output

Temperature

Operating temperature**

Storage temperature

Mechanical data

Overall width

Housing material

Approvals

Reliable separation according to EN 50 178

Coordination of insulation according to EN 50 178

Opto-coupler according to VDE 0884

Rated voltage

Rated impulse voltage

Overvoltage category

Pollution severity

Clearance/creepage path

Accessories, dimensions and connection data see

* at ambient temperature 20 °C/horizontal installation

Type	Cat. No.
WOS 2 24 Vuc	8275190000
WOZ 2	8430080000

Type	Cat. No.
WOS 2 115 Vuc	8296250000
WOZ 2	8429980000

Type	Cat. No.
WOS 2 230 Vuc	8275220000
WOZ 2	8430060000

21.6 V... 24 V ...26.4 V
16.3 mA ac at 24 V
13.5 mA dc at 24 V
ca.16 V
ca.11 V
8 ms ac 7 ms dc
25 ms ac 25 ms dc
LED green in output
LED red in output* ¹⁾
min. 2 mA...max. 1.5 A at Tb
25 °C...150 °C
min. 2 mA...max. 1.9 A at Tb
-40 °C...25 °C
Tb: temperature in module
direct at output driver
BTS442

short-circuit protection
5 Adc*
approx.15 mA at 28.8 V
19.2 Vdc... 24 Vdc ...28.8 Vdc
max. 400 mV
Polarity protection, varistor
yes / max. 96 h

-25 °C...+50 °C rowed
-40 °C...+85 °C

22.5 mm
Polyamide PA 66
UL/CSA

300 V
4 kV
III
2
≥ 5.5 mm
Page 298 + 308

115 V, max. 130 Vuc
3.1 mA ac at 115 V
2.8 mA dc at 115 V
ca.70 V
ca.55 V
10 ms ac 15 ms dc
30 ms ac 30 ms dc
LED green in output
LED red in output* ¹⁾
min. 2 mA...max. 1.5 A at Tb
25 °C...150 °C
min. 2 mA...max. 1.9 A at Tb
-40 °C...25 °C
Tb: temperature in module
direct at output driver
BTS442

short-circuit protection
5 Adc*
approx.15 mA at 28.8 V
19.2 Vdc... 24 Vdc ...28.8 Vdc
max. 400 mV
Polarity protection, varistor
yes / max. 96 h

-25 °C...+50 °C rowed
-40 °C...+85 °C

22.5 mm
Polyamide PA 66
UL/CSA

300 V
4 kV
III
2
≥ 5.5 mm
Page 298 + 308

230 V, max. 250 Vuc
12.0 mA ac at 230 V
1.8 mA dc at 230 V
ca.140 V
ca.100 V
10 ms ac 15 ms dc
30 ms ac 30 ms dc
LED green in output
LED red in output* ¹⁾
min. 2 mA...max. 1.5 A at Tb
25 °C...150 °C
min. 2 mA...max. 1.9 A at Tb
-40 °C...25 °C
Tb: temperature in module
direct at output driver
BTS442

short-circuit protection
5 Adc*
approx.15 mA at 28.8 V
19.2 Vdc... 24 Vdc ...28.8 Vdc
max. 400 mV
Polarity protection, varistor
yes / max. 96 h

-25 °C...+50 °C rowed
-40 °C...+85 °C

22.5 mm
Polyamide PA 66
UL/CSA

300 V
4 kV
III
2
≥ 5.5 mm
Page 298 + 308

*¹⁾ LED red:

hard short-circuit, LED permanently lit. The output is switched off and does **not** reset itself. To reset, the output or input must be temporarily disconnected from the supply voltage or input signal.

Overload: LED cycles, Rate: approx. 2 sec. on, approx. 30 sec. off. Module resets itself after the overload is removed.

Underload: LED permanently lit.

When an underload recognised, both LEDs are lit. The output is switched through

Opto-coupler in component housing WAVESERIES

Opto-coupler WAVESERIES

with AC voltage output and zero voltage switch

WOS 2 15-60 VUC

WOS 2 115 VUC

WOS 2 230 VUC

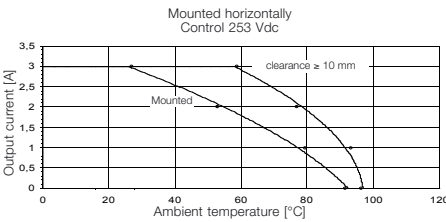

WOS 2 15-60 VUC • 8275440000

Schematic circuit diagram

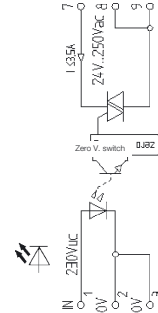
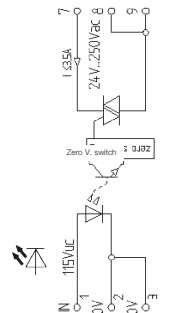
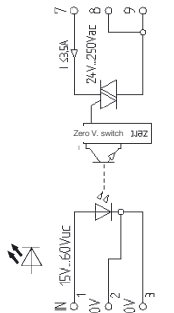

Ordering data	
Screw connection	
Tension clamp connection	

Input	
Input voltage	
Input current	
Making threshold	
Breaking threshold	
Switch-on delay	
Switch-off delay	
Status indicator normal operation	

Type	Cat. No.
WOS 2 15-60 Vuc	8275440000
WOZ 2	8430010000
15 Vuc...60 Vac/66 Vdc	
3.3 mA ac at 15 V	
3.8 mA dc at 15 V	
4.0 mA ac at 24 V	
4.6 mA dc at 24 V	
5.3 mA ac at 60 V	
5.6 mA dc at 60 V	
approx.11 V dc approx.15 V ac	
approx.5 V dc approx.14 V ac	
max. 20 ms	
max. 20 ms	
LED green in input	

Type	Cat. No.
WOS 2 115 Vuc	8259950000
WOZ 2	8430160000
115 Vuc max. 130 Vuc	
7.2 mA ac at 115 V	
3.8 mA dc at 115 V	
approx.90 V dc approx.90 V ac	
approx.70 V dc approx.70 V ac	
max. 20 ms	
max. 20 ms	
LED green in input	

Type	Cat. No.
WOS 2 230 VUC	8275400000
WOZ 2	8430150000
230 Vuc max. 250 Vuc	
11.8 mA ac at 230 V	
3.3 mA dc at 230 V	
approx.180 V dc approx.200 V ac	
approx.150 V dc approx.140 V ac	
max. 25 ms	
max. 25 ms	
LED green in input	

Output	
Output current	
Closed supply-circuit current (output not switched)	
Voltage supply	
Residual voltage	
Protection circuit	
Short-circuit in output	
Temperature	
Operating temperature**	
Storage temperature	
Mechanical data	
Overall width	
Housing material	
Approvals	
Reliable separation according to EN 50 178	
Coordination of insulation according to EN 50 178	
Opto-coupler according to VDE 0884	
Rated voltage	
Rated impulse voltage	
Overvoltage category	
Pollution severity	
Clearance/creepage path	

AC voltage output	
max. 230 V/3.5 A ac*	
2 mA	
24 Vac...250Vac (50Hz-60Hz)	
max. 1.6 V	
RC-combination with varistor	
-	
-25 °C...+50 °C rowed	
-40 °C...+85 °C	
22.5 mm	
Polyamide PA 66	
UL/CSA	
300 V	
4 kV	
III	
2	
≥ 5.5 mm	
Page 298 + 308	

AC voltage output	
max. 230 V/3.5 A ac*	
2 mA	
24Vac...250 Vac (50Hz-60Hz)	
max. 1.6 V	
RC-combination with varistor	
-	
-25 °C...+50 °C rowed	
-40 °C...+85 °C	
22.5 mm	
Polyamide PA 66	
UL/CSA	
300 V	
4 kV	
III	
2	
≥ 5.5 mm	
Page 298 + 308	

AC voltage output	
max. 230V/3.5A ac*	
2 mA	
24 Vac...250 Vac (50Hz-60Hz)	
max. 1.6 V	
RC-combination with varistor	
-	
-25 °C...+50 °C rowed	
-40 °C...+85 °C	
22.5 mm	
Polyamide PA 66	
UL/CSA	
300 V	
4 kV	
III	
2	
≥ 5.5 mm	
Page 298 + 308	

Accessories, dimensions and connection data see Page 298 + 308
* at ambient temperature 20 °C/horizontal installation

Opto-coupler in component housing WAVESERIES

Opto-coupler WAVESERIES

(4-channel, short-circuit proof)

WOS 2 24 VUC

WOS 2 115 VUC

WOS 2 230 VUC



Schematic circuit diagram

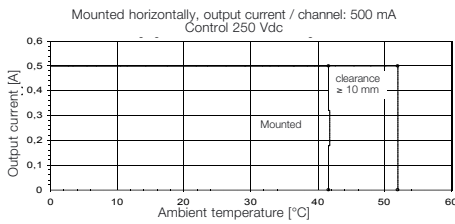

WOS 2 230 VUC • 8275340000

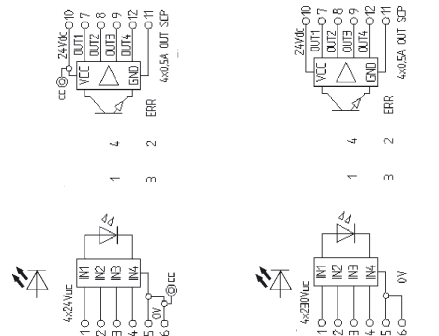

Ordering data	
Screw connection	
Tension clamp connection	

Type	Cat. No.
WOS 2 24 Vuc	8237720000
WOZ 2	8430110000

Type	Cat. No.
WOS 2 115 Vuc	8275360000
WOZ 2	8430130000

Type	Cat. No.
WOS 2 230 Vuc	8275340000
WOZ 2	8430140000

Input	
Input voltage	18 Vuc ... 30 Vuc
Input current	2.8 mA ac at 24 V 3.7 mA dc at 24 V
Making threshold	ca.13 V dc ca.14 V ac
Breaking threshold	ca.10 V dc ca.13 V ac
Switch-on delay	20 ms ac 7.0 ms dc
Switch-off delay	46 ms ac 50 ms dc
Status indicator normal operation	LED green in output
Status indicator short-circuit, underload, overload	LED red in output*

short-circuit protection	
Output current	max. 500 mA per channel
Output total current	max. 2 A
Voltage supply	12 Vdc... 24 Vdc ...28 Vdc
Response threshold	typ. 0.9 A min. 0.65 A, max. 1.2 A, $R_{\theta 2\Omega}$
Residual voltage	≤ 0.65 V, at 500 mA
Protection circuit	Polarity protection, varistor
Synchronisation factor	100 %
Lamp load	max. 3 W

short-circuit protection	
Output current	max. 500 mA per channel
Output total current	max. 2 A
Voltage supply	12 Vdc... 24 Vdc ...28 Vdc
Response threshold	typ. 0.9 A min. 0.65 A, max. 1.2 A, $R_{\theta 2\Omega}$
Residual voltage	≤ 0.65 V, at 500 mA
Protection circuit	Polarity protection, varistor
Synchronisation factor	100 %
Lamp load	max. 3 W

short-circuit protection	
Output current	max. 500 mA per channel
Output total current	max. 2 A
Voltage supply	12 Vdc... 24 Vdc ...28 Vdc
Response threshold	typ. 0.9 A min. 0.65 A, max. 1.2 A, $R_{\theta 2\Omega}$
Residual voltage	≤ 0.65 V, at 500 mA
Protection circuit	Polarity protection, varistor
Synchronisation factor	100 %
Lamp load	max. 3 W

Output ¹⁾	
Output current	max. 500 mA per channel
Output total current	max. 2 A
Voltage supply	12 Vdc... 24 Vdc ...28 Vdc
Response threshold	typ. 0.9 A min. 0.65 A, max. 1.2 A, $R_{\theta 2\Omega}$
Residual voltage	≤ 0.65 V, at 500 mA
Protection circuit	Polarity protection, varistor
Synchronisation factor	100 %
Lamp load	max. 3 W
Temperature	
Operating temperature	-25 °C...+50 °C rowed
Storage temperature	-40 °C...+85 °C
Mechanical data	
Overall width	22.5 mm
Housing material	Polyamide PA 66
Approvals	UL/CSA

Reliable separation according to EN 50 178	
Coordination of insulation according to EN 50 178	
Opto-coupler according to VDE 0884	
Rated voltage	150 V
Rated impulse voltage	2.5 kV
Overvoltage category	III
Pollution severity	2
Clearance/creepage path	≥ 3 mm

Reliable separation according to EN 50 178	
Coordination of insulation according to EN 50 178	
Opto-coupler according to VDE 0884	
Rated voltage	150 V
Rated impulse voltage	2.5 kV
Overvoltage category	III
Pollution severity	2
Clearance/creepage path	≥ 3 mm

Reliable separation according to EN 50 178	
Coordination of insulation according to EN 50 178	
Opto-coupler according to VDE 0884	
Rated voltage	300 V
Rated impulse voltage	4 kV
Overvoltage category	III
Pollution severity	2
Clearance/creepage path	≥ 5.5 mm

Accessories, dimensions and connection data see	Page 298 + 308
-------------------------------------------------	----------------

Accessories, dimensions and connection data see	Page 298 + 308
-------------------------------------------------	----------------

Accessories, dimensions and connection data see	Page 298 + 308
-------------------------------------------------	----------------

Accessories, dimensions and connection data see	Page 298 + 308
-------------------------------------------------	----------------

¹⁾ Protection circuit for output load necessary, page 107

Opto-coupler in component housing WAVESERIES

Opto-coupler WAVESERIES

with high switching frequency

WOS 1 5 VTTL
50 kHz

WOS 1 12-28 VDC
100 kHz



Schematic circuit diagram

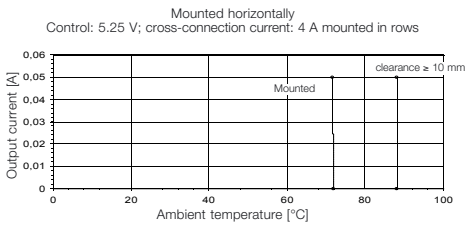

WOS 1 5 VTTL 50 kHz • 8275210000

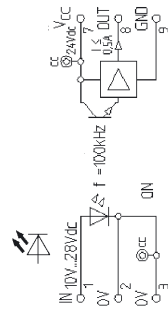
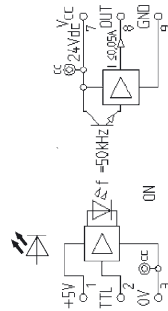

Ordering data

Screw connection

Tension clamp connection

Input

Input voltage

Input current

Supply voltage

Input resistance

Making threshold

Breaking threshold

Input frequency

Switch-on delay

Switch-off delay

Status indicator normal operation

Output

Voltage supply

Supply nominal current

Output current

Residual voltage

Protection circuit

Temperature

Operating temperature

Storage temperature

Mechanical data

Overall width

Housing material

Approvals

Reliable separation according to EN 50 178

Coordination of insulation according to EN 50 178

Opto-coupler according to VDE 0884

Rated voltage

Rated impulse voltage

Overvoltage category

Pollution severity

Clearance/creepage path

Accessories, dimensions and connection data see

Type Cat. No.

WOS 1 5 VTTL 50 kHz

8275210000

WOZ 2 **8430070000**

Type Cat. No.

WOS 1 12-28 Vdc/100 kHz

8275450000

WOZ 2 **8430000000**

12V dc...28 Vdc

5.5 mA at 12 Vdc

7.9 mA at 24 Vdc

8.8 mA at 28 Vdc

4.75 Vdc ... 5.25 Vdc

110 KΩ

approx. 5 V dc

approx. 4 V dc

100 kHz at $R_{load} = 470 \Omega$

1 μ s

3 μ s

LED green in input circuit

21.6 Vdc...**24 Vdc**...26.4 Vdc

approx. 5.4 mA, output not

switched

≤ 50 mA

≤ 1.5 V at 50 mA

Polarity protection, varistor

-25 °C...+60 °C rowed

-40 °C...+85 °C

22.5 mm

Polyamide PA 66

UL/CSA

300 V

4 kV

III

2

≥ 5.5 mm

Page 298 + 308

Opto-coupler in component housing EG5

power opto-couplers

With "online" check-back indication of the load ratio

- Power opto-couplers for load currents up to 4 A.
- Short-circuit proof
- Patented "online" load indication and check-back indication
 - optical indication
 - status indication via 3-coloured LEDs
 - electrical indication
 - 2-bit "online" data signal for check-back indication of the load performance to a PLC or similar
- Module fulfils protective separation in accordance with VDE 0106 Part 101 and EN 50 178 (rated voltage 300 V)
- Internal opto-coupler according to with DIN VDE 0884
- Insulation voltage 4 kV_{eff}
- Clearance and creepage distances ≥ 8 mm

EGO 5 PKR 24 Vac/dc



Schematic circuit diagram

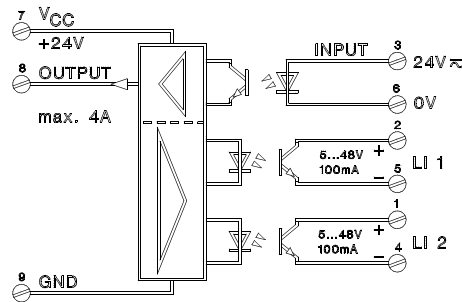

Indication and check-back indication of load ratio

Input	Load Indication	LI 1	LI 2	LED	Output
Low	x x x	L	L	off	low
High	Normal	L	H	green	high
High	Error ¹⁾	H	L	red	low
High	Open Load ²⁾	H	H	yellow	high

Ordering data

Type	Cat. No.
EGO 5 PKR	8220870000

Rated data

Input	
Input voltage	24 Vac/dc, min 20 Vac/dc, max 30 Vac/dc
Input current (at U _N)	12 mA (24 Vdc) 13 mA (24 Vac)
Rated input consumption	195 mW, 220 mVA
Max. input frequency dc	≤ 30 Hz, switching ratio 1 : 2
Typ. switch-on delay	2 ms
Typ. switch-off delay	7 ms
Max. input frequency ac	≤ 10 Hz

Output

Supply voltage	Screw connection 0.5...4 mm ² 20...30 Vdc
Max. output current	4 A
Reverse polarity protection	present
Short-circuit conditions	short-circuit-protected (switches output off immediately; auto switch-on when short-circuit eliminated)
Thermal short-circuit	≤ 12 A, output switches off and on again automatically after certain time.

Load Indication LI 1, LI 2

Supply voltage	5...48 Vdc
Max. current	100 mA
Max. voltage drop	1.6 V
Storage temperature	-40 °C...+60 °C
Ambient temperature	-20 °C...+40 °C
- rowed on mounting rail without clearances	-20 °C...+40 °C
- rowed with clearances	-20 °C...+50 °C

Insulation coordination EN 50 178

Overvoltage category	IV
Pollution severity	2

Accessories, dimensions and connection data see

Page 307, Fig. VII

¹⁾ Error: short-circuit, overload, over- or under voltage at output, overtemperature in the module

²⁾ Open load: Underload recognition at active input: type 500 mA (max. 1.5 A) at 25 °C. Open load will be indicated at I_{Load} ≥ 500 mA depending on switching status.

Opto-coupler in component housing EG7

power opto-couplers

- Pluggable on socket RS EG 7 with combination foot TS 32, 35
- Overall width **10 mm**

OST EG7 2 A

- Short circuit protected and over load-safe output
- 3-colour status-LED for output current indication
- Reliable separation acc. to DIN VDE 0884



OST EG7 4 A

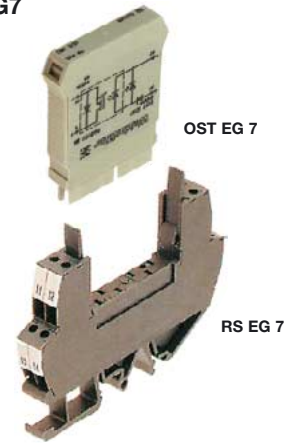

Schematic circuit diagram

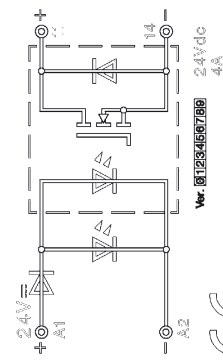
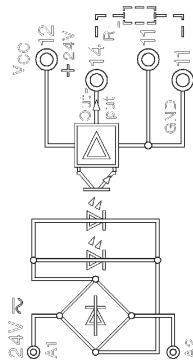

Ordering data	Type	Cat. No.
Puggable opto-coupler, without socket	OST EG7 2 A	826905000
socket for pluggable opto-coupler with combin. foot TS 32, 35	RS EG7	819383000

Ordering data	Type	Cat. No.
Puggable opto-coupler, without socket	OST EG7 4 A	828172000
socket for pluggable opto-coupler with combin. foot TS 32, 35	RS EG7	819383000

Rated data	Type	Cat. No.
Conductor connection	Lugs for socket RS EG7	819383000
Input voltage	24 Vac/dc ± 20 %	
Input current	dc: 5.5 mA ac: 6 mA	
Input power	dc: 132 mW ac: 145 mW	
Reliably switched on	19.2 V	
Reliably switched off	2.4 V	
Status indicator	LED green, yellow, red	
Reverse polarity protection	-	
Switch-on delay	12 ms	
Switch-off delay	17 ms	
Max. Switching frequency	100 Hz (resistive load/2 A/ Switching ratio 1 : 2)	
Output supply voltage	24 Vdc ± 30 %	
Switching current	2 A	
Voltage drop at max. load current	≤ 0.2 V, short-circuit proof and overload proof	

Rated data	Type	Cat. No.
Conductor connection	Lugs for socket RS EG7	819383000
Input voltage	21.6 Vdc	26.4 Vdc
Input current	10.5 mA	12.0 mA
Input power	230 mW	320 mW
Reliably switched on	21.6 V	
Reliably switched off	2 V	
Status indicator	LED green	
Reverse polarity protection	present	
Switch-on delay	typ. 10 µs	
Switch-off delay	typ. 45 µs	
Max. Switching frequency	100 Hz (resistive load/4 A/ Switching ratio 1 : 2)	
Output supply voltage	21.6...26.4 Vdc	
Switching current	4 A	
Voltage drop at max. load current	≤ 0.2 V, not short-circuit proof and not overload proof	

Status indicator:	Green LED	output set
	Yellow LED	output set, no activity, < 500 mA
	Red LED	output set, short-circuit
	LED off	output not set
Storage temperature		- 25...+ 60 °C
Operating temperature		- 25...+ 60 °C
- rowed on mounting rail without clearances		0...+ 40 °C
- rowed with clearances		0...+ 50 °C

Status indicator:	LED green	output set
		normal function
Storage temperature		- 25...+ 60 °C
Operating temperature		- 25...+ 60 °C
- rowed on mounting rail without clearances		0...+ 40 °C
- rowed with clearances		0...+ 50 °C

Insulation coordination to EN 50 178	Type	Cat. No.
Reliable separation	according to DIN VDE 0884	
Overvoltage category	III	
Pollution severity	2	
Accessories, dimensions and connection data see	Page 304	

Insulation coordination to EN 50 178	Type	Cat. No.
Reliable separation	-	
Overvoltage category	III	
Pollution severity	2	
Accessories, dimensions and connection data see	Page 304	

Opto-coupler in component housing EG7

Opto-couplers

- With combination foot for TS 15, TS 32 or TS 35
- Pluggable on socket RS EG 7 with combination foot TS 32, 35
- Overall width **10 mm**
- **Reliable separation according to DIN VDE 0884**

EGO EG 7
OST EG 7
RS EG 7

EGO EG 7



OST EG 7



RS EG 7

Schematic circuit diagram

5 V-

12 V0

24 V0

48 V0

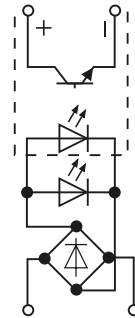

Ordering data

Combination foot for TS 15, TS 32, TS 35

Type Cat. No.
EGO EG7 **8092490000**

Type Cat. No.
EGO EG7 **8092510000**

Type Best.-EGO
EGO EG7 **8092530000**

Type Cat. No.
EGO EG7 **8092550000**

Plug-in opto-coupler, without engagement socket

OST EG7 **8234560000**

OST EG7 **8234570000**

OST EG7 **8234580000**

OST EG7 **8234590000**

Engage. socket for opto-coupler with combin. foot TS 32, 35

RS EG7 **8193830000**

RS EG7 **8193830000**

RS EG7 **8193830000**

RS EG7 **8193830000**

Rated data

Input voltage

5 V- ±20 %

12 V0 ±20 %

24 V0 ±20 %

48 V0 ±20 %

Switch-on current

3 V-

12 V/4.5 mA for max. 10 ms

12 V/4.5 mA for max. 10 ms

12 V/4.5 mA for max. 10 ms

Making threshold, typical

3 V-

6.5 V-

15.5 V-

31.5 V-

Rated input current DC

6.8 mA

7.5 V-

16.5 V-

45 V-

Rated input current AC

3 mA

33.5 mA

2.8 mA

2.8 mA

Rated input consumption

40 mW/50 mVA

40 mW/50 mVA

3.4 mA

3.2 mA

Output supply voltage

5...48 V-

5...48 V-

70 mW/90 mVA

135 mW/155 mVA

Output current

5...48 V-

100 mA

100 mA

100 mA

Max. output current

300 mA

300 mA

300 mA

300 mA

Switch-on time (first time)

6 ms for $U_N = 5 V-$

6 ms for $U_N = 12 V-$

5 ms for $U_N = 24 V-$

5 ms for $U_N = 48 V-$

Switch-off time

12 ms for $U_N = 5 V-$

12 ms for $U_N = 12 V-$

15 ms for $U_N = 24 V-$

15 ms for $U_N = 48 V-$

Switching frequency

15 Hzdc

15 Hzdc

15 Hzdc

15 Hzdc

Storage temperature

-40...+60 °C

-40...+60 °C

-40...+60 °C

-40...+60 °C

Ambient temperature

-25...+60 °C

-25...+60 °C

-25...+60 °C

-25...+60 °C

Connection

Insulation coordination to EN 50 178

Protective separation

acc. to DIN VDE 0884

acc. to DIN VDE 0884

acc. to DIN VDE 0884

acc. to DIN VDE 0884

Clearances and creepage distances

≥ 5.5 mm

≥ 5.5 mm

≥ 5.5 mm

≥ 5.5 mm

Rated impulse voltage

6 kV

6 kV

6 kV

6 kV

Overtoltage category

III

III

III

III

Pollution severity

2

2

2

2

Accessories

Cross connection comb 16-pole

Type Cat. No.
QB 16/10.16 **1650330000**

Type Cat. No.
QB 16/10.16 **1650330000**

Type Cat. No.
QB 16/10.16 **1650330000**

Type Cat. No.
QB 16/10.16 **1650330000**

Further accessories, dimensions and connection data see

Page 304

Page 304

Page 304

Page 304

Opto-coupler in component housing EG7

EGO EG 7



EGO EG 7

115 V0

230 V9

230 Vdc

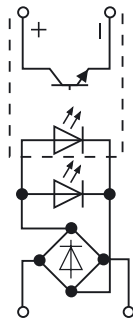

Type	Cat. No.
EGO EG7	8092570000

OST EG7	8234600000
RS EG7	8193830000

115 V0 ±20 %	230 V- ±20 %	230 Vdc ±20 %
115 V/90 mA for 5 ms	230 V/110 mA for 2 ms	230 V- /110 mA for 2 ms
70 V-	140 V-	140 V- (for testing only)
72 V-	-	-
3.3 mA	3.8 mA	1.8 mA
5.5 mA	-	-
400 mW/500 mVA	836 mVA	-
5...48 V-	5...48 V-	-
100 mA	100 mA	100 mA
300 mA	300 mA	300 mA
5 ms for UN = 115 V-	5 ms for UN = 230 V-	-
18 ms for UN = 115 V-	18 ms for UN = 230 V-	-
15 Hzdc	12 Hz	-
-40...+60 °C	-40...+60 °C	-40...+60 °C
-25...+60 °C	-25...+60 °C	-25...+60 °C
acc. to DIN VDE 0884	acc. to DIN VDE 0884	acc. to DIN VDE 0884
≥ 5.5 mm	≥ 5.5 mm	≥ 5.5 mm
6 kV	6 kV	6 kV
III	III	III
2	2	2
Type	Type	Type
Cat. No.	Cat. No.	Cat. No.
QB 16/10.16	1650330000	QB 16/10.16
1650330000	1650330000	1650330000

QB 16/10.16	1650330000
-------------	-------------------

Page 304

Opto-couplers for long control cables

- with combination foot for TS 15, TS 32 or TS 35
- plugs onto locking socket RS EG 7 with combination TS 32, 35
- overall width **10 mm**
- **protective separation acc. to DIN VDE 0884**
- RC-input for suppressing noise signals
- reliable switching performance by interference on the control side

EGO EG 7 RC/ OST EG 7 RC



OST EG 7 RC

RS EG 7 RC

115 V0

230 V9

Schematic circuit diagram

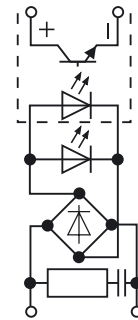

Type	Cat. No.
EGO EG7	8397420000

OST EG7	8315590000
---------	-------------------

115 V0 ±20 %	230 V- ±20 %
115 V/90 mA for 5 ms	230 V/110 mA for 2 ms
70 V-	140 V-
72 V-	-
3.3 mA	14 mA/110 mA (2 ms)
9 mA/90 mA (5 ms)	-
400 mW/500 mVA	836 mVA
5...48 V-	5...48 V-
100 mA	100 mA
300 mA	300 mA
9 ms for UN = 115 V-	15 ms for UN = 230 V-
25 ms for UN = 115 V-	15 ms for UN = 230 V-
12 Hzdc	12 Hz
-40...+60 °C	-40...+60 °C
-25...+60 °C	-25...+60 °C
acc. to DIN VDE 0884	acc. to DIN VDE 0884
≥ 5.5 mm	≥ 5.5 mm
6 kV	6 kV
III	III
2	2
Type	Type
Cat. No.	Cat. No.
QB 16/10.16	1650330000
1650330000	1650330000

QB 16/10.16	1650330000
-------------	-------------------

Page 304

Ordering data
Combination foot for TS 15, TS 32, TS 35
Pluggable opto-coupler, without locking socket

Locking socket for pluggable opto-coupler with combin. foot TS 32, 35

Rated data
Input voltage
Switch-on current
Making threshold, typ.
Rated input current DC
Rated input current AC
Rated input consumption
Output supply voltage
Output current
Max. output current
Switch-on time (first time)
Switch-off time
Switching frequency

Storage temperature
Ambient temperature

Insulation coordination to EN 50 178
Reliable separation
Clearances / creepage distances
Rated impulse voltage
Overvoltage category
Pollution severity

Accessories
Cross connec. comb 16-pole

Further Accessories, dimensions and connection data see

Solid State relay on locking socket PLUGSERIES

Complete module

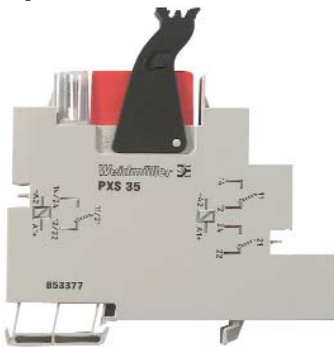

DC version

Type/Version	Cat. No.
Screw connection	
POS 24Vdc/24Vdc 2.5A	8610840000
POS 24Vdc/230Vac 2A	8610860000
POS 24Vdc/24Vdc 1A	8610890000
POS 24Vdc/24Vdc 5A	8610900000
POS 24Vdc/230Vac 4A	8610910000
Tension clamp connection	
POZ 24Vdc/24Vdc 2.5A	8610920000
POZ 24Vdc/230Vac 2A	8610930000
POZ 24Vdc/24Vdc 1A	8610960000
POZ 24Vdc/24Vdc 5A	8610970000
POZ 24Vdc/230Vac 4A	8610980000

AC version

Type/Version	Cat. No.
Screw connection	
POS 24Vac/24Vdc 2.5A	8615600000
POS 24Vac/24Vdc 5A	8615620000
POS 24Vac/230Vac 4A	8615590000
Tension clamp connection	
POZ 24Vac/24Vdc 2.5A	8615640000
POZ 24Vac/24Vdc 5A	8615650000
POZ 24Vac/230Vac 4A	8615630000

Accessories SSR Standard



- Compact dimensions (29 x 25.4 x 12.7)
- Combines with PLUGSERIES socket PXS / PXZ, LED indicator PLED and PRC holding clamp to a complete functioning unit.
- Fully compatible with electromechanical relays in standard design
- Control voltage 24 VAC / DC
- Rated switching current 24 VDC, 24 VAC/DC, or 230 VAC
- Up to 5 A continuous current
- Mounts onto PCB or socket
- High mounting density possible

Dimensions

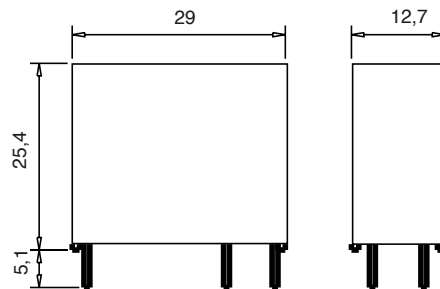

Ordering data

Type	Cat. No.
SSR 24 VUC/24VDC 5A	8576350000

Type	Cat. No.
SSR 24 VUC/230VAC 4A	8576360000

Technical data

Input (typical values at 20 °C)	
Input voltage min. AC/DC	15 V
Input voltage max. AC/DC	30 V
Input current min. AC/DC	6.1 mA
Input current max. AC/DC	12 mA
Drop-out voltage AC/DC	2.5 V
Resistance	2.100 Ω

DC Version

15 V	15 V
30 V	30 V
6.1 mA	6.1 mA
12 mA	12 mA
2.5 V	2.5 V
2.100 Ω	2.100 Ω

Output

max. switching current DC	5 A
max. switching current AC	3 A (4 A at 20 °C)
min. switching current DC	1 mA
min. switching current AC	50 mA
Rated switching voltage DC	24 V
Rated switching voltage AC	230 V ~

5 A

1 mA	50 mA
24 V	230 V ~

Switch voltage range DC	0...30 V
Switch voltage range AC	12...275 V

max. forward anode voltage at max. switching current DC	0.3 V
max. forward anode voltage at max. switching current AC	1.1 V

max. switch-on time DC	2 ms
max. switch-on time AC (50 Hz)	12 ms

max. switch-off time DC	18 ms
max. switch-off time AC (50 Hz)	20 ms

Insulation

Test voltage control circuit - switching circuit DC	2.5 kV _{eff}
Test voltage control circuit - switching circuit AC	4 kV _{eff}

0...30 V	12...275 V
----------	------------

0.3 V	1.1 V
-------	-------

2 ms	12 ms
------	-------

18 ms	20 ms
-------	-------

2.5 kV _{eff}	4 kV _{eff}
-----------------------	---------------------

Further data

Operating temperature range	-40 °C...+50 °C
Weight	approx. 18 g
Approvals	cUL, UL recognized
Celduc	SPD07505
Further accessories, dimensions and connection data	see page 83

-40 °C...+50 °C	-40 °C...+50 °C
approx. 18 g	approx. 18 g
cUL, UL recognized	cUL, UL recognized
SPD07505	SPA07420
see page 83	see page 83

DC version

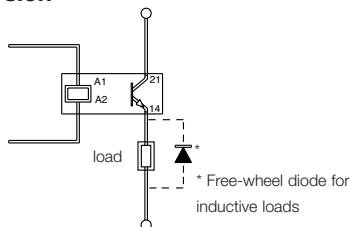

AC version

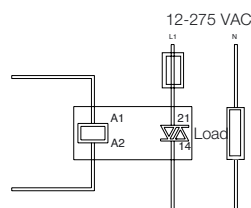

Solid State relay on locking socket PLUGSERIES

Accessories SSR / RT



Dimensions

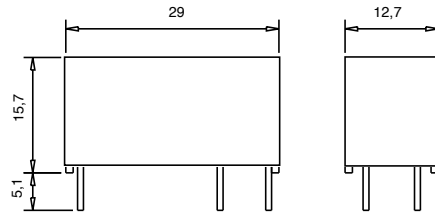

- Compact dimensions (29 x 15.7 x 12.7)
- Combines with PLUGSERIES socket PXS / PXZ, LED indicator PLED and PRC holding clamp to a complete functioning unit.
- Fully compatible with standard electromechanical relays RT
- Control voltage 24 VAC / DC
- Rated switching current 24 VDC, 24 VAC/DC, or 230 VAC
- Up to 5 A continuous current
- Mounts onto PCB or socket
- High mounting density possible

Ordering data	Type	Cat. No.	Type	Cat. No.	Type	Cat. No.
	SSR 24 VUC/24VDC 2.5A	8576340000	SSR 24 VUC/230VAC 2A	8576370000	SSR 24 VUC/24VUC 1A	8576380000
Technical data	DC Version	AC Version	AC/DC Version			
Input (typical values at 20 °C)						
Input voltage min. AC/DC	15 V	15 V	15 V			
Input voltage max. AC/DC	30 V	30 V	30 V			
Input current min. AC/DC	6.1 mA	6.1 mA	6.1 mA			
Input current max. AC/DC	12 mA	12 mA	12 mA			
Drop-out voltage AC/DC	2.5 V	2.5 V	2.5 V			
Resistances	2.100 Ω	2.100 Ω	2.100 Ω			
Output						
max. switching current DC	2.5 A					
max. switching current AC		2 A				
max. switching current AC/DC			1 A			
min. switching current DC	1mA					
min. switching current AC		50mA				
min. switching current AC/DC			1mA			
Rated switching voltage DC	24 V					
Rated switching voltage AC		230 V				
Rated switching voltage AC/DC			24 V			
Switch voltage range DC	0...30 V					
Switch voltage range AC		12...275 V				
Switch voltage range AC/DC			0...30 V			
max. forward anode voltage at max. switching current DC	0.5 V					
max. forward anode voltage at max. switching current AC		1 V				
max. forward anode voltage at max. switching current AC/DC			0.9 V			
max. switch-on time DC	2 ms					
max. switch-on time AC (50 Hz)		12 ms				
max. switch-on time AC/DC (50 Hz)			5 ms			
max. switch-off time DC	18 ms					
max. switch-off time AC (50 Hz)		20 ms				
max. switch-off time AC/DC (50 Hz)			12 ms			
Insulation						
Test voltage control circuit - switching circuit DC	2.5 kV _{eff}					
Test voltage control circuit - switching circuit AC		4 kV _{eff}				
Test voltage control circuit - switching circuit AC/DC			4 kV _{eff}			
Further data						
Operating temperature range	-40 °C...+50 °C	-40 °C...+50 °C	-40 °C...+50 °C			
Weight	approx.11 g	approx.11 g	approx.11 g			
Approvals	cUL, UL recognized	cUL, UL recognized	cUL, UL recognized			
Celduc	STD07205	STA07220	STN07105			
Further accessories, dimensions and connection data	see page 83	see page 83	see page 83			

AC version

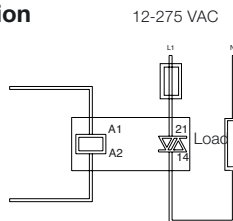

DC version

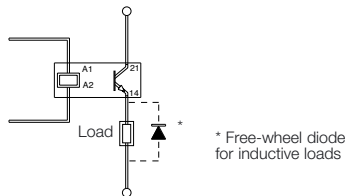

AC/DC version

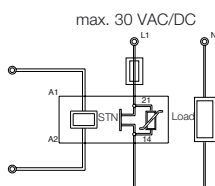

Opto-coupler on locking socket profile RS 40

Opto-couplers for signal input

RS 40

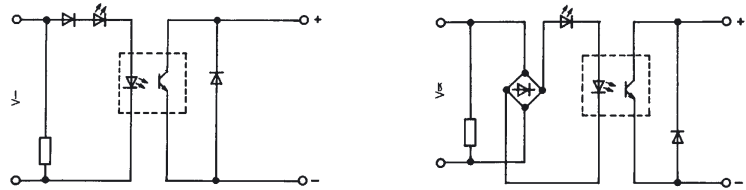

Rated data

Input voltage
Rated consumption - (W)
Rated consumption - (VA)
Output supply voltage
Voltage drop at max. load current
Output current

5 V ²⁾	12 V ₀ ± 10 %	24 V ⁻ ± 10 %	24 V ₀ ± 10 %	48 V ₀ ± 10 %	115 V ₀ , +5%-15%	230 V ⁻ , +5%-15%
0.045 W	0.25 W	0.51 W	0.34 W	0.55 W	0.33 W	
	0.32 VA		0.5 VA	0.65 VA	0.65 VA	0.52 VA
5...48 V ⁻¹⁾	5...48 V ⁻¹⁾	5...48 V ⁻¹⁾	5...48 V ⁻¹⁾	5...48 V ⁻¹⁾	5...48 V ⁻¹⁾	5...48 V ⁻¹⁾
< 0.9 V	< 1.6 V	< 0.9 V	< 1.6 V	< 1.6 V	< 1.5 V	< 1.5 V
20 mA	100 mA	20 mA	100 mA	100 mA	100 mA	100 mA

Derating curve

a = rowed on mounting rail without clearances

b = rowed with clearances ≥ 20 mm

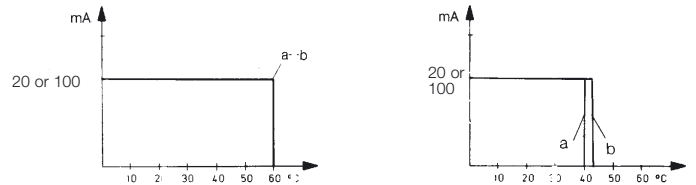
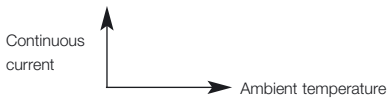

Pulse duration, limiting overload current (not periodic)
Sperrstrom (Ruhestrom), max. at U = 48 V
Switch-on time (cyclic operation)
Switch-off time (cyclic operation)
Max. switching frequency DC voltage
Max. switching frequency AC voltage
Switching ratio

0.2 A/10 ms	0.8 A/10 ms	0.2 A/10 ms	0.8 A/10 ms	0.8 A/10 ms	0.8 A/10 ms	0.8 A/10 ms
0.16 mA	0.16 mA	0.16 mA	0.16 mA	0.16 mA	0.16 mA	0.16 mA
≤ 12 μs	≤ 6 ms	≤ 30 μs	≤ 2 ms	≤ 5 ms	≤ 10 ms	≤ 6 ms
≤ 15 μs	≤ 13 ms	≤ 60 μs	≤ 15 ms	≤ 20 ms	≤ 23 ms	≤ 18 ms
3 kHz	20 Hz	3 kHz	20 Hz	< 20 Hz	10 Hz	
	< 10 Hz		< 10 Hz	< 10 Hz		
1 : 2	10 Hz 1 : 2	1 : 2	10 Hz 1 : 1	10 Hz 1 : 1	10 Hz 1 : 1	10 Hz 1 : 1

Insulation coordination to EN 50 178

Rated voltage
Rated impulse voltage
Overvoltage category
Pollution severity
Clearances and creepage distances
Opto-coupler
Test voltage (corresponds 100% module test)
Module is immune to interference
Insulation voltage
Input - output/mounting rail
Storage temperature
Ambient temperature
- , rowed on mounting rail without clearances
- , rowed with clearances ≥ 20 mm

300 V	300 V	300 V	300 V	300 V	300 V	300 V
6 kV	6 kV	6 kV	6 kV	6 kV	6 kV	6 kV
IV	IV	IV	III	IV	IV	IV
2	2	2	2	2	2	2
≥ 5.5 mm	≥ 5.5 mm	≥ 5.5 mm	≥ 5.5 mm	≥ 5.5 mm	≥ 5.5 mm	≥ 5.5 mm
according to DIN VDE 0884	according to DIN VDE 0884	according to DIN VDE 0884	according to DIN VDE 0884	according to DIN VDE 0884	according to DIN VDE 0884	according to DIN VDE 0884
according to DIN VDE 0884	according to DIN VDE 0884	according to DIN VDE 0884	according to DIN VDE 0884	according to DIN VDE 0884	according to DIN VDE 0884	according to DIN VDE 0884
non-destructive test 1 kV	non-destructive test 1 kV	non-destructive test 1 kV	non-destructive test 1 kV	non-destructive test 1 kV	non-destructive test 1 kV	non-destructive test 1 kV
acc. to IEC 801-4 severity 4	acc. to IEC 801-4 severity 4	acc. to IEC 801-4 severity 4	acc. to IEC 801-4 severity 4	acc. to IEC 801-4 severity 4	acc. to IEC 801-4 severity 4	acc. to IEC 801-4 severity 4
4 kV _{eff} 1 min.					4 kV _{eff} 1 min.	
-40 °C...+85 °C					-40 °C...+70 °C	
-25 °C...+60 °C					-25 °C...+40 °C	
-25 °C...+60 °C					-25 °C...+45 °C	

¹⁾ Not TTL-compatible

²⁾ Conditionally level-compatible

Opto-coupler on locking socket profile RS 40

RS 40



Ordering data				
Connection method	Input voltage	Function indicator	Screw connection (GSE)	Disconnect plug with screw connection (BL/SL)
	5 V ²⁾	Yellow LED	1118861001	1161560000
	12 V ₀	Green LED	1118761001	1161660000
	24 V ₋	Yellow LED	1160961001	1161760000 1177860000 ¹⁾
	24 V ₀	Yellow LED Green LED	1117461001 8065031001	1119460000
	48 V ₀	Green LED	1161061001	1161860000
	115 V ₀	Green LED	1161161001	1161960000
	230 V ₋	Green LED	1161461001	1162060000
	230 V ₋	Red LED		8182690000

Connection data				
Insulation stripping length			7 mm	6 mm
Conductor cross-section		0.5...2.5 mm ²	0.5...1.5 mm ²	
			AWG 26...14	AWG 26...16
Dimensions				
Mounting width			11.2 mm	11.2 mm
Length (perpendicular to mounting rail)			70 mm	74 mm
Height TS/TS 35 x 7.5			56 mm/51.5 mm	56 mm/51.5 mm

¹⁾ Output 5 VTTL-compatible
²⁾ Conditionally level-compatible

Opto coupler on locking socket with multiple interface RSM

(Opto-couplers)

RSM 4 OS

4 opto-couplers

RSM 8 OS

8 opto-couplers

Note!

During operation and maintenance please observe the relevant ESD measures.

(ESD endangered area)

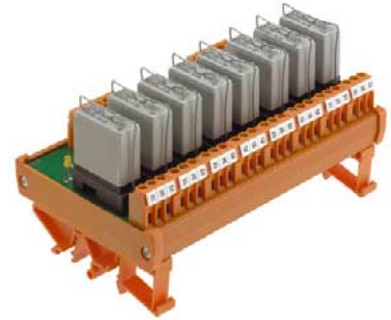

Also available as relay coupler, see page 84/85

Schematic circuit diagram

Opto coupler 24 Vdc / 2A

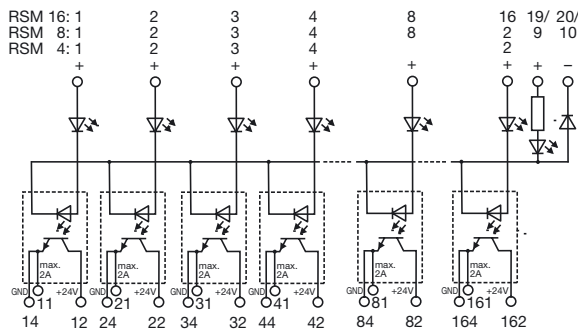

DC voltage/positive switching (joint negative)

Standard Opto coupler 5...48 Vdc / 100 mA

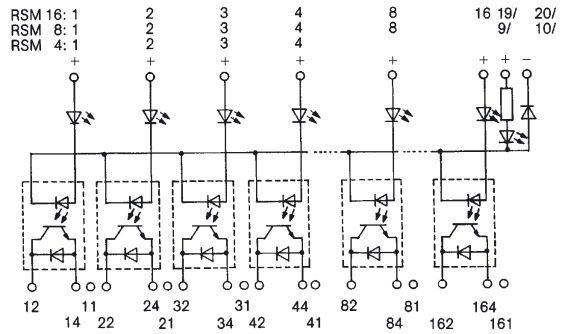

Rated data

Rated data	5 V ⁻¹ ±10 %	24 V ⁻ ±10 %	24 V ⁰ ±10 %	24 V ⁻ +10 %
Input voltage	5 V ⁻¹ ±10 %	24 V ⁻ ±10 %	24 V ⁰ ±10 %	24 V ⁻ +10 %
Rated consumption – (W)	60 mW	400 mW	300 mW	288 mW
Rated consumption ~ (VA)	–	–	0.35 VA	–
Output operating voltage	5...48 V ¹⁾	5...48 V ¹⁾	5...48 V ¹⁾	24 V ±10 %
Voltage drop at max. load current	<1.6 V	<1.6 V	<1.6 V	≤0.4 V
Output current	0.1 A	0.1 A	0.1 A	2 A
Derating curve				
a = Continuous operation				
b = Switching mode				
Continuous current				
Ambient temperature				
Pulse duration, limiting overload current (not periodic)	0.8 A/10 ms	0.8 A/10 ms	0.8 A/10 ms	12 A/10 ms
Max. reverse current (static current), at U	0.16 mA	0.16 mA	0.16 mA	12 mA
Switching frequency	100 Hz	100 Hz	20 Hz	max. 100 Hz
Storage temperature	–40 °C...+85 °C	–40 °C...+85 °C	–40 °C...+85 °C	–40 °C...+60 °C
Ambient temperature				
–, rowed on mounting rail without clearances	–25 °C...+60 °C	–25 °C...+60 °C	–25 °C...+60 °C	–25 °C...+60 °C
–, rowed with clearances x 20 mm	–25 °C...+60 °C	–25 °C...+60 °C	–25 °C...+60 °C	–25 °C...+60 °C
Dimensions				
Mounting width				
RSM 4	75 mm	75 mm	75 mm	75 mm
RSM 8	145 mm	145 mm	145 mm	145 mm
RSM 16	285 mm	285 mm	285 mm	285 mm
Length (perpendicular to mounting rail)	87 mm	87 mm	87 mm	87 mm

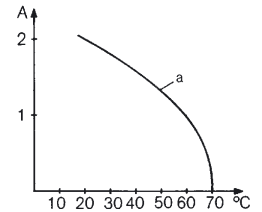
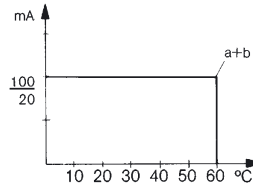

¹⁾ Not TTL-compatible

Opto coupler on locking socket with multiple interface RSM

RSM 16 OS

16 Opto couplers

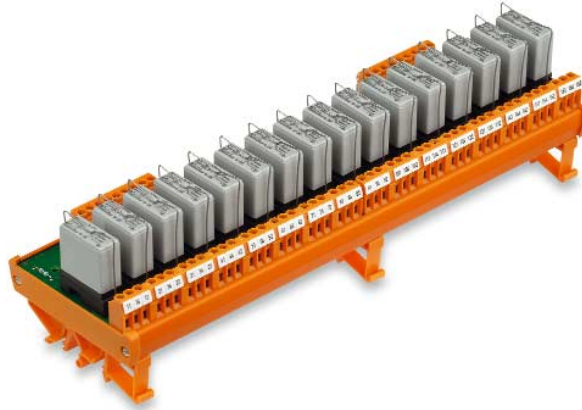

DC/negative switching (common positive)

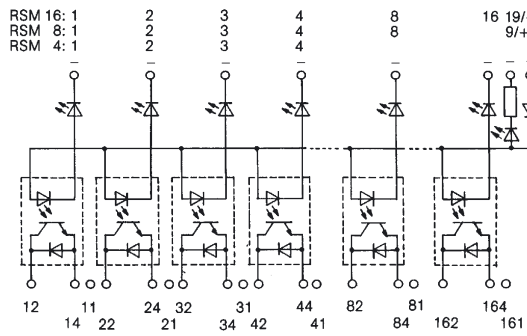

DC/AC voltage

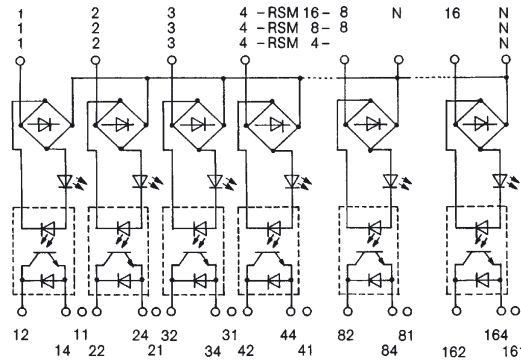

Ordering data

Conn. method	Input voltage	RSM 4 OS w/o. optocoupl.	4 optocoupl.	RSM 8 OS w/o. optocoupl.	8 optocoupl.	RSM 16 OS w/o. optocoupl.	16 optocoupl.	Positive switching ³⁾	Negative switching ⁴⁾	Cat. No.	Mount. width (mm)
Screw/	5 V ⁻²⁾		•			•		•		1123661001	75
							•	•		1124061001	145
							•	•		1124461001	285
		•						•		8017581001	75
			•*					•		1123861001	75
			•*						•	1123761001	75
	24 V-			•				•		8003671001	145
				•					•	8021391001	145
					•*			•		1124261001	145
						•		•		8018221001	285
						•			•	8082471001	285
							•*	•		1124661001	285
	24 V0		•*							1125161001	75
					•*					1125261001	145

* equipped as standard with opto-coupler 5...48 Vdc / 100 mA

Connection data

Insulation stripping length	7 mm				
Conductor cross-section	0.5...2.5 mm ² /AWG 26...14				
Replacement opto-c.	Type	Input voltage	Output voltage	Output current	Cat. No.
	OS	5 V ⁻⁵⁾ ±10 %	24 V- ±20 %	0.1 A	1121100000
	OS	12 V ⁻⁵⁾ ±10 %	5...48 V-	0.1 A	1124800000
	OS	12 V0 ±10 %	5...48 V-	0.1 A	1121200000
	OS	24 V ⁻⁵⁾ ±10 %	5...48 V-	0.1 A	1124900000
	OS	24 V ⁻⁵⁾ ±10 %	24 V- +10 %	2.0 A	1170200000
	OS	24 V ⁻⁵⁾ ±10 %	250 V~	0.1 A	1153200000
	OS	24 V0 ±10 %	5...48 V-	0.1 A	1121300000

²⁾ 5 V TTL Input voltage on request

³⁾ Common negative potential, positive is switched

⁴⁾ Common positive potential, negative is switched

⁵⁾ Not suitable for DC/AC version

Opto coupler, locking socket for semi-conductor relays

Single and multiple socket interface-unit

- Advantages of semiconductor relays:
- Wear-free switching also with high switching frequencies
 - Bounce-free switching
 - No electromagnetic interferences
 - High insulation-voltage between load and control circuit

Note!
The relevant ESD measures are to be observed during commissioning and maintenance (ESD endangered area)

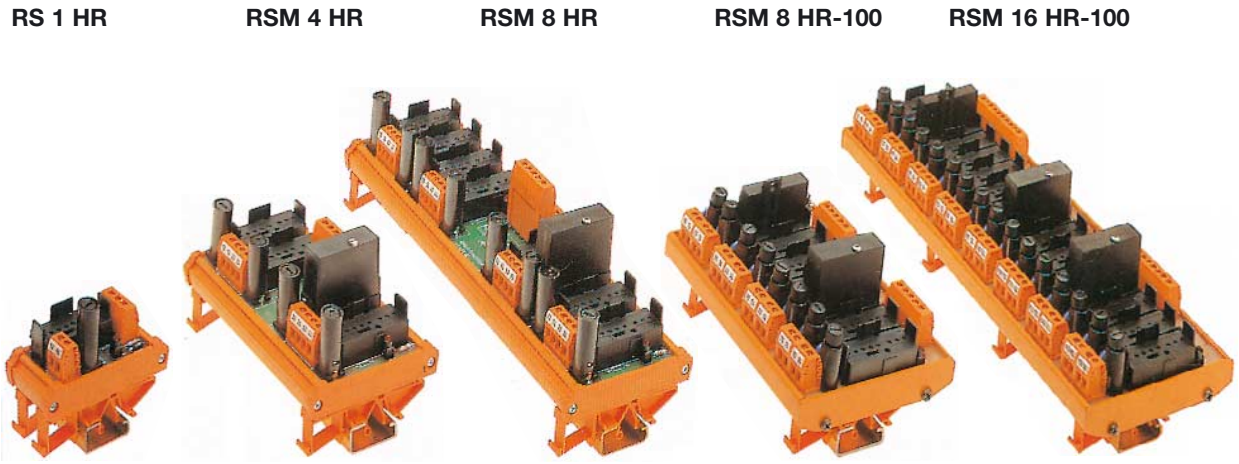

Schematic circuit diagram

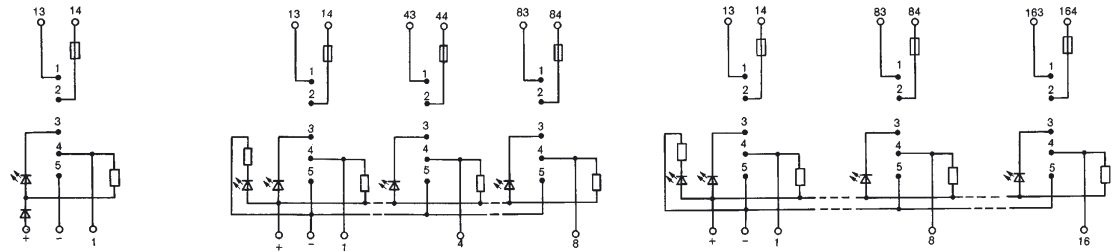

Ordering data	Type	Cat. No.	Type	Cat. No.	Type	Cat. No.	Type	Cat. No.	Type	Cat. No.
	RS 1 HR	1166961001	RSM 4 HR	1167061001 ³⁾	RSM 8 HR	1167161001 ³⁾	RSM 8 HR-100	1166261001 ³⁾	RSM 16 HR-100*	1167261001 ³⁾
Rated data (with input module)¹⁾										
Input voltage, max.	250 V~		250 V~		250 V~		250 V~		250 V~	
Input current (per channel)	25 mA		25 mA		25 mA		25 mA		25 mA	
Max. output voltage	24 V0		24 V0		24 V0		24 V0		24 V0	
Output current (per channel), max.	Depending on module		Depending on module		Depending on module		Depending on module		Depending on module	
Rated data (with output module)¹⁾										
Input voltage, max.:	24 V0		24 V0		24 V0		24 V0		24 V0	
Input current (per channel)	Depending on module		Depending on module		Depending on module		Depending on module		Depending on module	
Max. output supply voltage	250 V		250 V		250 V		250 V		250 V	
Max. output current (per channel)	Depending on module		Depending on module		Depending on module		Depending on module		Depending on module	
Auxiliary voltage	24 V- ±10 %		24 V- ±10 %		24 V- ±10 %		24 V- ±10 %		24 V- ±10 %	
Status indicator	LED red		LED red		LED red		LED red		LED red	
Fuse	5x20, 5 A quick		5x20, 5 A quick		5x20, 5 A quick		5x20, 5 A quick		5x20, 5 A quick	
Storage temperature	-40 °C...+70 °C		-40 °C...+70 °C		-40 °C...+70 °C		-40 °C...+70 °C		-40 °C...+70 °C	
Ambient temperature	-25 °C...+70 °C		-25 °C...+70 °C		-25 °C...+70 °C		-25 °C...+70 °C		-25 °C...+70 °C	
	Dependent on semiconductor relay used		Dependent on semiconductor relay used		Dependent on semiconductor relay used		Dependent on semiconductor relay used		Dependent on semiconductor relay used	
Connection data										
Conductor cross-section	0.5...2.5 mm ²		0.5...2.5 mm ²		0.5...2.5 mm ²		0.5...2.5 mm ²		0.5...2.5 mm ²	
Screw connection	-		-		-		-		-	
Male connect. block DIN 41651 ²⁾	-		-		10-pole		10-pole		20-pole	
„Sub-D“-connection ²⁾	-		-		15-pole		15-pole		25-pole	
Dimensions										
Mounting width	35 mm		130 mm		249 mm		156 mm		305 mm	
Length (perpendicular to mounting rail)	87 mm		87 mm		87 mm		109 mm		109 mm	

¹⁾ The rating data depend on the used module
²⁾ on request

³⁾ Mixed placement of input and output modules is not valid.

Semi-conductor relays

Solid state relays for signal input and output

Input module HRE 24
DC/DC

Input module HRE 115/HRE 230
AC/DC

Output module HRA 230
DC/AC

Output module HRA 60
DC/DC

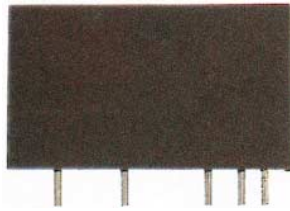

Schematic circuit diagram

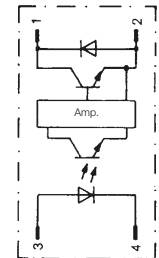
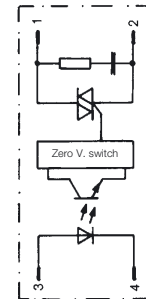
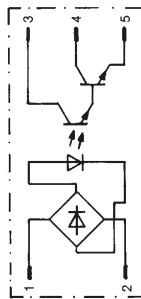
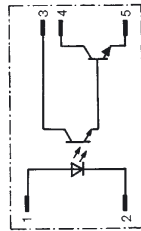
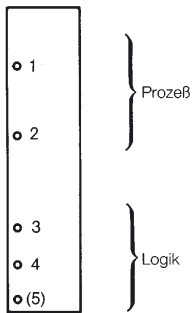

Ordering data	Type	Cat. No.	Type	Cat. No.	Type	Cat. No.	Type	Cat. No.	Type	Cat. No.
	HRE 24	117440000	HRE 115	117450000	HRE 230	117460000	HRA 230	117410000	HRA 60	117430000
Rated data										
Input voltage	10...32 V- (process)		90...140 V0 (process)		180 V...280 V0 (process)		18...32 V- (Logic)		18...32 V- (Logic)	
Input current at max. V	21.33 mA		10 mA		6.4 mA		-		-	
Input resistance	1.5 kΩ		14 kΩ		44 kΩ		2.2 kΩ		2.2 kΩ	
Switch-on voltage	-		-		-		3 V		3 V	
Switch-off voltage	-		-		-		1 V		1 V	
Max. output operating voltage	18...32 V (Logic) ¹⁾		18...32 V (Logic) ¹⁾		18...32 V (Logic) ¹⁾		24...250 V~ ¹⁾²⁾ (process)		5...60 V~ ¹⁾²⁾ (process)	
Voltage drop at max. load current	0.4 V		0.4 V		0.4 V		-		-	
Max. output current (Continuous test)	100 mA		100 mA		100 mA		3 A		3 A, resistive load	
Derating curve										
a = self-cooling										
b = mounted on 2 k/W heat sink										
Continuous current										
Ambient temperature										
Min. Load current	-		-		-		20 mA		-	
Leakage current in off-condition at rated load voltage	max. 100 µA		max. 100 µA		max. 100 µA		6 mA		1 mA	
Surge current	-		-		-		75 A/20 ms		5 A/1 s	
Switch-on time	5 ms		20 ms		20 ms		≤ 1/2 Period		100 µs	
Switch-off time	5 ms		20 ms		20 ms		≤ 1/2 Period		750 µs	
Input impulse	-		-		-		unlimited, t _{min} 100 µs		unlimited, t _{min} 100 µs	
Storage temperature	-40 °C...+100 °C		-40 °C...+100 °C		-40 °C...+100 °C		-40 °C...+100 °C		-40 °C...+100 °C	
Ambient temperature	-20 °C...+ 70 °C		-25 °C...+ 70 °C		-25 °C...+ 70 °C		-25 °C...+ 70 °C		-25 °C...+ 70 °C	

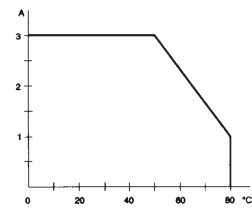

¹⁾ 250 V max. in connection with HR modules. Only negative-switching when used on HR-socket!

²⁾ For inductive loads the module must be protected with diode or varistor.



Timers

The IT product family of electronic delay timers from Weidmüller are the optimum solution for industrial tasks.

The product family IT offers:

- Response delay (ITR)
- Wiping contact without control input (ITWo)
- Wiping contact with control input (ITWw)
- Turn-off delay without control input (ITTo)
- Turn off delay without control input (ITTw)
- Pulse generator (ITTT)
- Multifunction (ITM)
- Multifunction (ITMF)

Designation of types:

- I** = Industry
- T** = Timer
- R** = Response Delay
- Wo** = Wiping contact relay without control input
- Ww** = Wiping contact relay with control input
- To** = Turn -off delay without control input
- Tw** = Turn-off delay with control input
- TT** = Two Times
- M** = Multifunction
- MF** = Multifunction Four

Time ranges and supply voltages of delay timer relays

The modules' functions for 4 or 7 time can be precisely selected via the rotary button.

The multiple voltage ranges of the supply voltage allow for a wide area of use in industry (see table).

Product	Time	Range		Voltage supply
ITR	0.1s - 100h	0.1 s - 1 s	1 min - 10 min	24 VDC/24...24UVAC
ITWo, ITTT		1 s - 10 s	0.1 h - 1 h	
ITTw		0.1 min - 1 min	1 h - 10 h	
ITWw		10 h - 100 h		
ITMF, ITM				
ITTo	0.06 s - 160 s	0.06 s - 0.6 s	2 s - 20 s	24 V - 240 VAC
		0.25 s - 2.5 s	16 s - 160 s	24 VDC

Output of the timing relays

The load in every module is switched by a changeover relay (250 V, 8 A). The multifunction module (ITM) switches both changeover relays immediately or, one changeover relay immediately and the other changeover relay delayed.

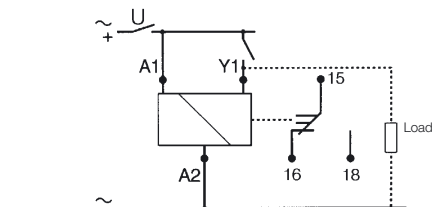
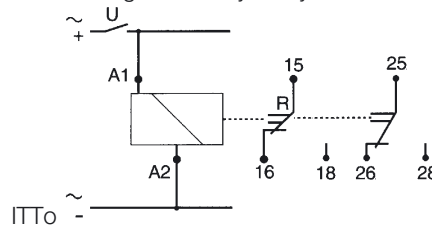

ITR, ITP, ITWo, ITWw, ITTw, ITTT, ITMF

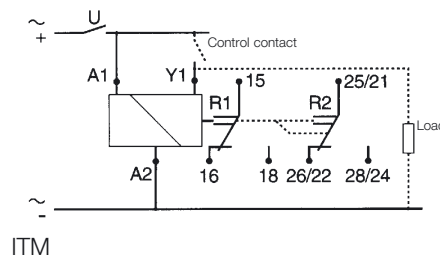

ITM

Characteristic data of output contacts

Limit values by resistive load

Service life of contacts by resistive load

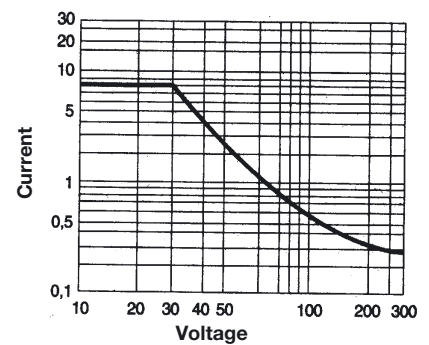
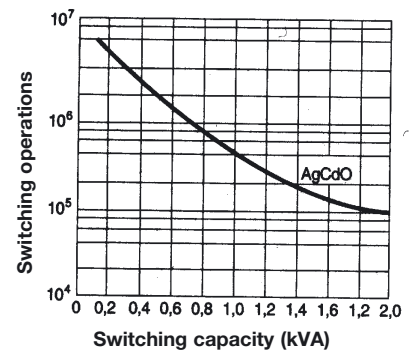

Functions of the Timers

Response delay ITR timer relay

As soon as the operating voltage is applied, the preset delay period T begins. After time period T has expired, output R connects the load.



Wiping contact timer relay without control input ITWo

When the operating voltage is applied, output R connects the load immediately. After the preset delay period T has expired, output R disconnects the load.



Wiping contact timer relay with control input ITWw

As soon as the operating voltage is applied, a pulse (e. g. 50 ms) or a voltage is applied to control input Y1. Output R connects the load immediately. After the preset delay period T has expired, output R disconnects the load.

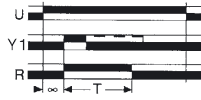

Turn-off delay timer relay without control input ITTo

As soon as the operating voltage is applied, output R connects the load. Delay period T does not begin until the operating voltage is switched off. After delay period T has expired, output R disconnects the load.



Turn-off delay timer relay with control input ITTw

After the operating voltage has been applied and control input Y1 has been activated, output R connects the load for an indefinite period of time. When the control input is opened and after the preset time period T has expired, the output disconnects the load.

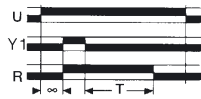

Pulse generator ITTT

The repeat cycles starts with two individually adjustable times after applying the supply voltage. There is a different starting state for each delay.

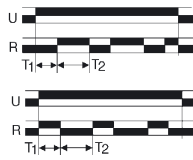

Multifunction ITM/ITMF

Function A: Response delay

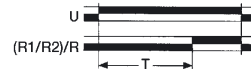

As soon as the operating voltage is applied, the preset delay period T begins. After time period T has expired, output R connects the load.

Function Ac: Response delay and turn-off delay

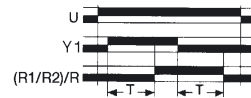

As soon as operating voltage has been applied and control input Y1 has closed, delay period T begins. After time period T has expired, output R connects the load (delayed response). When control input Y1 is opened, the output disconnects the load after the preset time period has expired (delayed turn-off).

Function At: Additive response delay

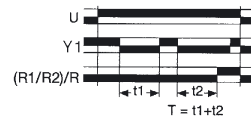

As soon as the operating voltage has been applied and delay period T has expired, output R connects the load. At control input Y1 the contact break intervals are accumulated (additive process). As soon as the operating voltage is switched off, the load at output R is disconnected.

Function B: Wiping contact with control input



As soon as the operating voltage has been applied, a pulse (min 50 ms) or a voltage can be applied to control input Y1. Output R connects the load immediately. After delay period T has expired, output R disconnects the load.

Function Bw: Wiping function

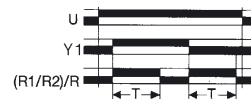

The operating voltage must be applied. As soon as a voltage is applied to control input Y1, output R connects the load for the preset time T. After time period T has expired, output R disconnects the load. As soon as the control input is opened, output R once more connects the load for the duration of time period T. After time period T has expired, output R disconnects the load.

Function C: Turn-off delay with control input

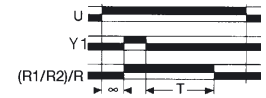

As soon as the operating voltage has been applied and control input Y1 has been activated, output R connects the load for an indefinite period of time. When the control input is opened and after the preset time period T has expired, the output disconnects the load.

Function D: Pulse generator (begins in the zero position)

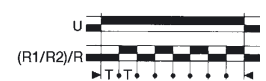

As soon as the operating voltage has been applied, output R simultaneously switches the load alternately between the zero position and operating position for the period of the preset time T. With this function, the cycle begins at the zero position.

Function Di: Pulse generator (begins in the operating position)



As soon as the operating voltage has been applied, output R simultaneously switches the load alternately between the zero position and operating position for the period of the preset time T. With this function, the cycle begins at the operating position.

Function H: Wiping contact without control input



As soon as the operating voltage is applied, output R connects the load immediately. After delay period T has expired, output R disconnects the load.

Function Ht: Wiping contact, additive

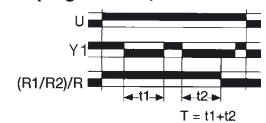

As soon as the operating voltage is applied, output R connects the load immediately. At control input Y1 the contact break intervals are accumulated (additive process) and when the preset delay period has expired, output R disconnects the load.

- U = Operating voltage
- R = Output relay or load
- T = Delay
- Y1 = Control input

Timers

Status LED

Two LED's show the status of the modules:

- green LED = supply voltage connected
- yellow LED = relay output active (not for ITTO)

Marking

Marking is done on a removable tag or on the marking area. The function is printed on the **front** of the module.

Control lamp for verifying contact

A control lamp can be wired parallel to input Y1 to show the status of control input.

Assembly

Mount direct onto DIN TS 35 mounting rails.

on DIN rail

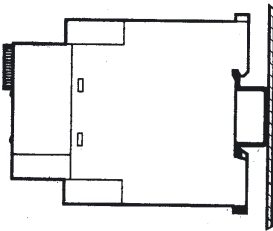

on panel using M4 screws

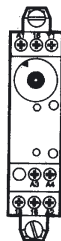
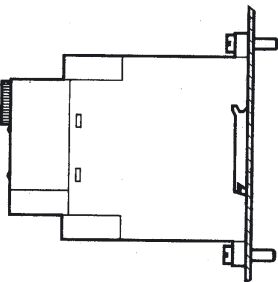

Approvals and standards

This relay has a high resistance to interference. The housing material is self-extinguishing (UL94/V0).

Manufacturing to IEC/VDE and UL/CSA approvals permit worldwide usage.

- IEC 255 static measuring relays
- IEC529 testers and test procedures
- IEC 664 regulations for high-voltage fuses for motor circuits
- IEC 801 EMC compatibility
- VDE 0110 insulation coordination for low-voltage electrical equipment
- VDE 0435 relays with fixed times

Connection technology

Clamping yoke has the following capacities:

- 2 x 1.5 mm² with ferrule
- 2 x 2.5 mm² without ferrule
- 1 x 4 mm² without ferrule

Dimensions IT

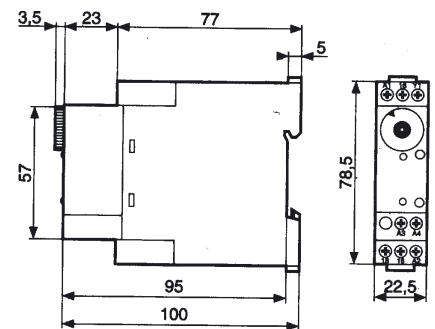

Multifunctional Timers

- Response delay
- Response delay and turn-off delay
- Additive response delay
- Wiping contact with control input
- Wiping function
- Turn-off delay with control input
- Pulse generator (begins in the zero position)
- Pulse generator (begins in the operating position)
- Wiping contact without control input
- Wiping contact, additive

Schematic circuit diagram

ITM Multifunctional timer relay

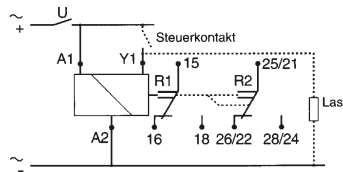

Ordering data

Contact	changeover
Time periods	0.1 s - 100 h 1 s, 10 s, 1 min 1 h, 10 h, 100 h
Repeat accuracy (const. parameter)	± 0.5%
Accuracy of indication acc. to IEC 1812-1	± 10% (25 °C)
Input	
Input voltage	12 V...240 Vac/dc / 50...60 Hz
Voltage tolerance	85 - 110% U _N
Duty factor	100 %
Rated power consumption	7 VA / 230 V~
Min pulse duration type	≥ 50 ms
Max. reset time at voltage interruption	≤ 100 ms
Protection against voltage interruption	> 10 ms
Output	
Contact	2 changeover
Contact material	AgCdO
Service life	- mechanical 5 x 10 ⁶ switching operations - electrical 10 ⁵ switching operations at 2000 VA resistive load
Switching current	- max. 8 A ₀ / changeover contact - min. 100 mA ₀
Max. switching voltage	250 V ₀
Switching current	2000 VA / 80 W
Status indicators	
Voltage applied	green LED
Relay output active	yellow LED
Approvals	UL / CSA
Standards	IEC 529/IEC 664/IEC 801/IEC 255 VDE 0435/VDE 0110
Temperature	- Storage temperature -30°C...+70°C - Operating temperature -20°C...+60°C
Clearance/creepage path, acc. to IEC 664/VDE 0110	4 kV
Protection category IEC 529	IP 20
- Terminal block	IP 50
- Front	DIN rail 35 mm
Mounting	Category III
Installation category to IEC 664	
Connection	
- with ferrule	2 x 1.5 mm ²
- without ferrule	2 x 2.5 mm ² / 1 x 4 mm ²
Enclosure material	self extinguishing
Weight, typ.	110 g

Type	Cat. No.
ITM	8362550000

Function A: Response delay

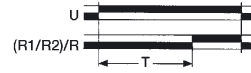

As soon as the operating voltage is applied, the preset delay period T begins. After time period T has expired, output R connects the load.

Function Ac: Response delay and turn-off delay



As soon as operating voltage has been applied and control input Y1 has closed, delay period T begins. After time period T has expired, output R connects the load (delayed response). When control input Y1 is opened and after the preset time period T has expired, the output disconnects the load (delayed turn-off).

Function At: Additive response delay

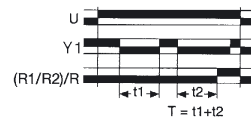

As soon as the operating voltage has been applied and delay period T has expired, output R connects the load. At control input Y1 the contact break intervals are accumulated (additive process). As soon as the operating voltage is switched off, the load at output R is disconnected.

Function B: Wiping contact with control input

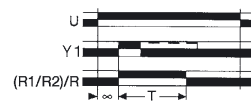

As soon as the operating voltage has been applied, a pulse (min 50 ms) or a voltage can be applied to control input Y1. Output R connects the load immediately. After delay period T has expired, output R disconnects the load.

Function Bw: Wiping function

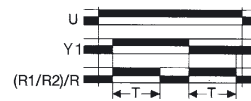

The operating voltage must be applied. As soon as a voltage is applied to control input Y1, output R connects the load for the preset time T. After time period T has expired, output R disconnects the load. As soon as the control input is opened, output R once more connects the load for the duration of time period T. After time period T has expired, output R disconnects the load.

Function C: Turn-off delay with control input



As soon as the operating voltage has been applied and control input Y1 has been activated, output R connects the load for an indefinite period of time. When the control input is opened and after the preset time period T has expired, the output disconnects the load.

Function D: Pulse generator (begins in the zero position)

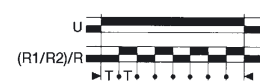

As soon as the operating voltage has been applied, output R simultaneously switches the load alternately between the zero position and operating position for the period of the preset time T. With this function, the cycle begins at the zero position.

Function Di: Pulse generator (begins in the operating position)

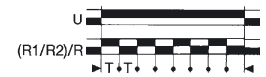

As soon as the operating voltage has been applied, output R simultaneously switches the load alternately between the zero position and operating position for the period of the preset time T. With this function, the cycle begins at the operating position.

Function H: Wiping contact without control input

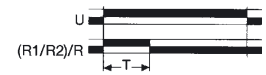

As soon as the operating voltage is applied, output R connects the load immediately. After delay period T has expired, output R disconnects the load.

Function Ht: Wiping contact, additive

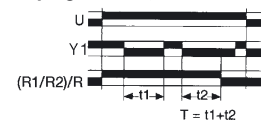

As soon as the operating voltage is applied, output R connects the load immediately. At control input Y1 the contact break intervals are accumulated (additive process) and when the preset delay period has expired, output R disconnects the load.

U = Operating voltage

R = Output relay or load

T = Delay

Y1 = Control input

Timers

ITTo

Turn-off delay timer relay **without** control input



ITTw

Turn-off delay timer relay **with** control input



Schematic circuit diagram

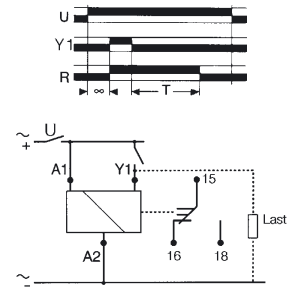
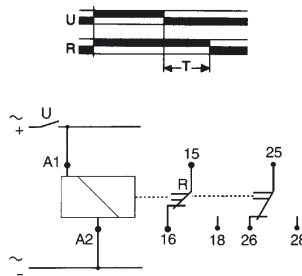

Ordering data

	Type	Cat. No.	Type	Cat. No.
Contact	ITTo	836260000	ITTw	8362610000
Time periods	Changeover 0.6 s -160 s (0.06 s - 0.6 s, 0.25 s - 2.5 s, 2 s - 20 s, 16 s - 160 s)		Changeover 0.1 s -100 h (0.1 s - 1 s, 1 s -10 s, 0.1 min - 1 min, 1 min - 10 min, 0.1 h - 1 h, 1 h - 10h)	
Repeat accuracy (const. parameter) Anzeigegenauigkeit gemäß IEC 1812-1	± 0.5% ± 10% (25 °C)		± 0.5% ± 10% (25 °C)	
Input	24 Vdc/ 24...240 Vac / 50...60 Hz		24 Vdc/ 24...240 Vac / 50...60 Hz	
Input voltage	85 - 110% U _N		85 - 115% U _N (110% for 240 V)	
Voltage tolerance	100 %		100 %	
Duty factor	0.5 W / 30 VA / 230 V~		0.5 W / 24 V- / 1 W / 48 V- / 2 VA / 48 V- 1.5 VA / 24 V- 12 VA / 230 V~	
Rated power consumption	-		≥ 50 ms ≤ 100 ms > 10 ms	
Min. switch-on time for the supply	≥ 50 ms		Relay output 1 changeover AgCdO 5 x 10 ⁶ switching operations 10 ⁵ switching operations at 1250 VA resistive load 8 A ₀ / changeover contact 100 mA ₀ 250 V ₀ 1250 VA / 80 W	
Min pulse duration type	≤ 100 ms		green LED	
Max. reset time at voltage interruption	> 10 ms		UL / CSA IEC 529/IEC 664/IEC 801/IEC 255 VDE 0435/VDE 0110	
Protection against voltage interruption			IEC 529/IEC 664/IEC 801/IEC 255 VDE 0435/VDE 0110	
Output	Relay output 2 changeover AgCdO 5 x 10 ⁶ switching operations 10 ⁵ switching operations at 1250 VA resistive load 8 A ₀ / changeover contact 100 mA ₀ 250 V ₀ 1250 VA / 80 W		Relay output 1 changeover AgCdO 5 x 10 ⁶ switching operations 10 ⁵ switching operations at 2000 VA resistive load 8 A ₀ 100 mA ₀ 250 V ₀ 2000 VA / 80 W	
Contact	2 changeover		green LED yellow LED	
Contact material	AgCdO		UL / CSA	
Service life	- mechanical 5 x 10 ⁶ switching operations - electrical 10 ⁵ switching operations at 1250 VA resistive load		IEC 529/IEC 664/IEC 801/IEC 255 VDE 0435/VDE 0110	
Switching current	8 A ₀ / changeover contact 100 mA ₀		IEC 529/IEC 664/IEC 801/IEC 255 VDE 0435/VDE 0110	
Max. switching voltage	250 V ₀		-30°C...+70°C -20°C...+60°C	
Switching current	1250 VA / 80 W		4 kV / 2 IP 20 IP 50	
Status indicators			4 kV / 2 IP 20 IP 50	
Voltage applied	green LED		DIN rail 35 mm Category III	
Relay output active			2 x 1.5 mm ² 2 x 2.5 mm ² / 1 x 4 mm ²	
Approvals	UL / CSA IEC 529/IEC 664/IEC 801/IEC 255 VDE 0435/VDE 0110		self extinguishing	
Standards	IEC 529/IEC 664/IEC 801/IEC 255 VDE 0435/VDE 0110		100 g	
Temperature	- Storage temperature -30°C...+70°C - Operating temperature -20°C...+60°C			
Clearance/creepage path. acc. to IEC 664/VDE 0110	4 kV / 2			
Protection category IEC 529 - Terminal block	IP 20 IP 50			
	- Front			
Mounting	DIN rail 35 mm Category III			
Installation category to IEC 664				
Connection				
- with ferrule	2 x 1.5 mm ²			
- without ferrule	2 x 2.5 mm ² / 1 x 4 mm ²			
Enclosure material	self extinguishing			
Weight, typ.	100 g			

Timers

ITWo

Wiping contact timer relay **without** control input



ITWw

Wiping contact timer relay **with** control input



Schematic circuit diagram

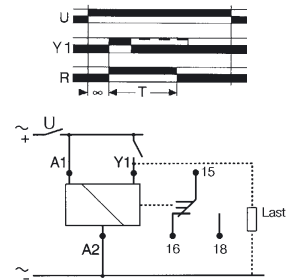
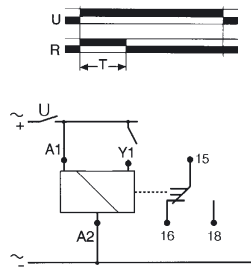

Ordering data

	Type	Cat. No.	Type	Cat. No.
Contact	ITWo	8362580000	ITWw	8362590000
Time periods	Changeover		Changeover	
	0.1 s - 100 h		0.1 s - 100 h	
	(0.1 - 1 s, 1 s - 10 s, 0.1 min. - 1 min.,		(0.1 - 1 s, 1 s - 10 s, 0.1 min. - 1 min.,	
	1 min. - 10 min., 0.1 h - 1 h, 1 h - 10 h, 100 h)		1 min. - 10 min., 0.1 h - 1 h, 1 h - 10 h, 100 h)	
Repeat accuracy (const. parameter)	± 0.5%		± 0.5%	
Accuracy of indication acc. to IEC 1812-1	± 10% (25 °C)		± 10% (25 °C)	
Input				
Input voltage	24 Vdc/ 24...240 Vac / 50...60 Hz		24 Vdc/ 24...240 Vac / 50...60 Hz	
Voltage tolerance	85 - 115% U _N (110% for 240 V)		85 - 115% U _N (110% for 240 V)	
Duty factor	100 %		100 %	
Rated power consumption	0.5 W / 24 V- 1.5 VA / 24 V~ 12 VA / 230 V~		0.5 W / 24 V- / 1 W / 48 V- / 2 VA / 48 V~ 1.5 VA / 24 V~ 12 VA / 230 V~	
Min pulse duration type	≥ 50 ms		≥ 50 ms	
Max. reset time at voltage interruption	≤ 100 ms		≤ 100 ms	
Protection against voltage interruption	> 10 ms		> 10 ms	
Output	Relay output		Relay output	
Contact	1 changeover		1 changeover	
Contact material	AgCdO		AgCdO	
Service life	5 x 10 ⁶ switching operations		5 x 10 ⁶ switching operations	
	10 ⁵ switching operations at 2000 VA resistive load		10 ⁵ switching operations at 2000 VA resistive load	
Switching current	8 A ₀		8 A ₀	
	100 mA ₀		100 mA ₀	
Max. switching voltage	250 V ₀		250 V ₀	
Switching current	2000 VA / 80 W		2000 VA / 80 W	
Status indicators				
Voltage applied	green LED		green LED	
Relay output active	yellow LED		yellow LED	
Approvals	UL / CSA		UL / CSA	
Standards	IEC 529/IEC 664/IEC 801/IEC 255 VDE 0435/VDE 0110		IEC 529/IEC 664/IEC 801/IEC 255 VDE 0435/VDE 0110	
Temperature	- Storage temperature -30°C...+70°C		- Storage temperature -30°C...+70°C	
	- Operating temperature -20°C...+60°C		- Operating temperature -20°C...+60°C	
Clearance/creepage path. acc. to IEC 664/VDE 0110	4 kV / 2		4 kV / 2	
Protection category IEC 529 - Terminal block	IP 20		IP 20	
	IP 50		IP 50	
Mounting	DIN rail 35 mm		DIN rail 35 mm	
Installation category to IEC 664	Category III		Category III	
Connection				
- with ferrule	2 x 1.5 mm ²		2 x 1.5 mm ²	
- without ferrule	2 x 2.5 mm ² / 1 x 4 mm ²		2 x 2.5 mm ² / 1 x 4 mm ²	
Enclosure material	self extinguishing		self extinguishing	
Weight, typ.	100 g		100 g	

Timers

ITTT

Pulse generator



ITMF

Multifunction - timer relay



Schematic circuit diagram

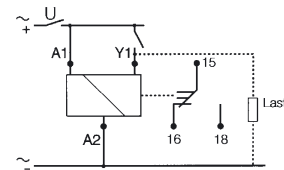
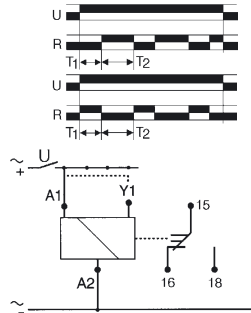

Ordering data	
Contact	
Time periods	
Repeat accuracy (const. parameter)	
Accuracy of indication acc. to IEC 1812-1	
Input	
Input voltage	
Voltage tolerance	
Duty factor	
Rated power consumption	
Min pulse duration type	
Max. reset time at voltage interruption	
Protection against voltage interruption	
Output	
Contact	
Contact material	
Service life	- mechanical
	- electrical
Switching current	- max.
	- min.
Max. switching voltage	
Switching current	
Status indicators	
Voltage applied	
Relay output active	
Approvals	
Standards	
Temperature	- Storage temperature
	- Operating temperature
Clearance/creepage path. acc. to IEC 664/VDE 0110	
Protection category IEC 529 - Terminal block	
	- Front
Mounting	
Installation category to IEC 664	
Connection	
- with ferrule	
- without ferrule	
Enclosure material	
Weight, typ.	

Type	Cat. No.
ITTT	8324050000
Changeover	
0.1 s - 100 h	
(0.1 - 1 s, 1 s - 10 s, 0.1 min. - 1 min., 1 min. - 10 min., 0.1 h - 1 h, 1 h - 10 h, 100 h)	
± 0.5%	
± 10% (25 °C)	
24 Vdc/ 24...240 Vac / 50...60 Hz	
85 - 115% U _N (110% for 240 V)	
100 %	
0.5 W / 24 V-	
1.5 VA / 24 V~	
12 VA / 230 V~	
≥ 50 ms	
≤ 100 ms	
> 10 ms	
Relay output	
1 changeover	
AgCdO	
5 x 10 ⁶ switching operations	
10 ⁵ switching operations at 2000 VA resistive load	
8 A ₀	
100 mA ₀	
250 V ₀	
2000 VA / 80 W	
green LED	
yellow LED	
UL / CSA	
IEC 529/IEC 664/IEC 801/IEC 255	
VDE 0435/VDE 0110	
-30°C...+70°C	
-20°C...+60°C	
4 kV / 2	
IP 20	
IP 50	
DIN rail 35 mm	
Category III	
2 x 1.5 mm ²	
2 x 2.5 mm ² / 1 x 4 mm ²	
self extinguishing	
100 g	

Type	Cat. No.
ITMF	8287770000
Changeover	
0.1 s - 100 h	
(0.1 - 1 s, 1 s - 10 s, 0.1 min. - 1 min., 1 min. - 10 min., 0.1 h - 1 h, 1 h - 10 h, 100 h)	
± 0.5%	
± 10% (25 °C)	
24 Vdc/ 24...240 Vac / 50...60 Hz	
85 - 115% U _N (110% for 240 V)	
100 %	
0.5 W / 24 V- / 1 W / 48 V-	
1.5 VA / 24 V~ / 2 VA / 48 V~	
12 VA / 230 V~	
≥ 50 ms	
≤ 100 ms	
> 10 ms	
Relay output	
1 changeover	
AgCdO	
5 x 10 ⁶ switching operations	
10 ⁵ switching operations at 2000 VA resistive load	
8 A ₀	
100 mA ₀	
250 V ₀	
2000 VA / 80 W	
green LED	
yellow LED	
UL / CSA	
IEC 529/IEC 664/IEC 801/IEC 255	
VDE 0435/VDE 0110	
-30°C...+70°C	
-20°C...+60°C	
4 kV / 2	
IP 20	
IP 50	
DIN rail 35 mm	
Category III	
2 x 1.5 mm ²	
2 x 2.5 mm ² / 1 x 4 mm ²	
self extinguishing	
100 g	

ITR

Response delay timer relay



Schematic circuit diagram

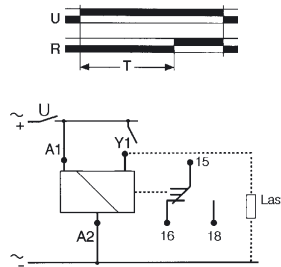

Ordering data	Type	Cat. No.
Contact	ITR	8362570000
Time periods	Changeover	
	0.1 s - 100 h	
	(0.1 - 1 s, 1 s - 10 s, 0.1 min. - 1 min.,	
	1 min. - 10 min., 0.1 h - 1 h, 1 h - 10 h, 100 h)	
Repeat accuracy (const. parameter)	± 0.5%	
Accuracy of indication acc. to IEC 1812-1	± 10% (25 °C)	
Input		
Input voltage	24 Vdc / 24...240 Vac / 50...60 Hz	
Voltage tolerance	85 - 115% U _N (110% for 240 V)	
Duty factor	100 %	
Rated power consumption	0.5 W / 24 V-	
	1.5 VA / 24 V~	
	12 VA / 230 V~	
Min pulse duration type	≥ 50 ms	
Max. reset time at voltage interruption	≤ 100 ms	
Protection against voltage interruption	> 10 ms	
Output	Relay output	
Contact	1 changeover	
Contact material	AgCdO	
Service life	5 x 10 ⁶ switching operations	
	10 ⁵ switching operations at 2000 VA resistive load	
Switching current	8 A ₀	
	100 mA ₀	
Max. switching voltage	250 V ₀	
Switching current	2000 VA / 80 W	
Status indicators		
Voltage applied	green LED	
Relay output active	yellow LED	
Approvals	UL / CSA	
Standards	IEC 529/IEC 664/IEC 801/IEC 255	
	VDE 0435/VDE 0110	
Temperature	- Storage temperature	-30°C...+70°C
	- Operating temperature	-20°C...+60°C
Clearance/creepage path. acc. to IEC 664/VDE 0110	4 kV / 2	
Protection category IEC 529 - Terminal block	IP 20	
	IP 50	
Mounting	DIN rail 35 mm	
Installation category to IEC 664	Category III	
Connection		
- with ferrule	2 x 1.5 mm ²	
- without ferrule	2 x 2.5 mm ² / 1 x 4 mm ²	
Enclosure material	self extinguishing	
Weight, typ.	100 g	

Timers

Signal conditioning DKZ/DKZA timer modules

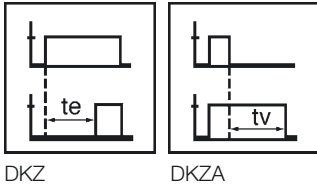

- Components for extending short pulses
- Provides PLC versions with switch-on/off delay
- Fixed times

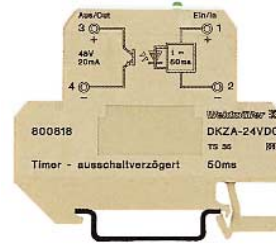

DKZ 24 Vac/dc

DKZA 24 Vac/dc

DKZA 24 Vac/dc

Schematic circuit diagram

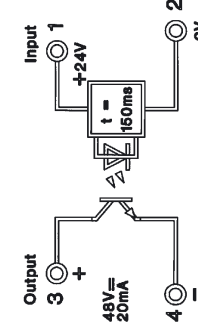
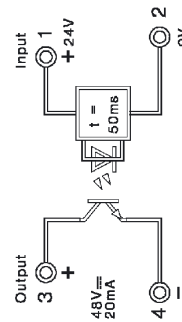
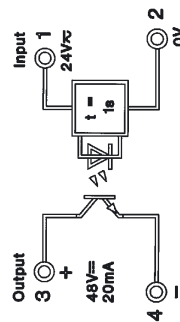

Ordering data	Type	Cat. No.	Type	Cat. No.	Type	Cat. No.
For TS 32	DKZ 24 Vac/dc 32	8008130000	DKZA 24 Vdc 32	8008120000	DKZA 24 Vdc 32	8020990000
For TS 35	DKZ 24 Vac/dc 35	8008190000	DKZA 24 Vdc 35	8008180000	DKZA 24 Vdc 35	8022110000
Technical data						
Input						
Input voltage	24 Vac/dc ±10 %		24 Vdc ±18 %		24 Vdc ±10 %	
Input nominal current	5.1 mA _{dc} /6.1 mA _{ac} ±10 %		6.7 mA ±10 %		6.7 mA ±10 %	
Input current (at first-time power-up)			200 mA ±10 %		200 mA ±10 %	
Input power	130 mW ±10 % / 150 mVA ±10 %		160 mW ±10 %		160 mW	
Switch-on delay	1s					
Switch-off delay	≤ 0.7 ms		50 ms		150 ms	
Min. pulse duration of input voltage			2 ms		2.5 ms	
Output						
Max. output voltage	5...48 Vdc		5...48 Vdc		5...48 Vdc	
Max. output current	20 mA		20 mA		20 mA	
Reverse current, max. (closed-circuit current)	≤ 0,16 mA (at 48 V)		≤ 0,16 mA (at 48 V)		≤ 0,16 mA (at 48 V)	
Max. voltage drop at max. load current	≤ 1 V		≤ 1,6 V		≤ 1,6 V	
Max. switching frequency	0.9 Hz		20 Hz		20 Hz	
Isolation coordinates acc. to DIN VDE 0160, Draft11/94						
Rated voltage	300 V		300 V		300 V	
Rated impulse voltage	4 kV		4 kV		4 kV	
Overvoltage category	III		III		III	
Pollution severity	2		2		2	
Clearance and creepage distances	≥4 mm		≥4 mm		≥4 mm	
Voltage proof, input/output-TS	4 kV _{eff}		4 kV _{eff}		4 kV _{eff}	
Operating temperature	without clearances -25 °C...+50 °C with clearances -25 °C...+50 °C		-25 °C...+50 °C -25 °C...+50 °C		-25 °C...+50 °C -25 °C...+50 °C	
Storage temperature	-40 °C...+85 °C		-40 °C...+85 °C		-40 °C...+85 °C	
Total width	6 mm		6 mm		6 mm	
Conductor	AWG 22...12		AWG 22...12		AWG 22...12	
Conductor cross-section	0.5...4 mm ²		0.5...4 mm ²		0.5...4 mm ²	
Reverse polarity protection	ja		ja		ja	
Accessories						
End plate	AP DKT4	0687560000	AP DKT4	0687560000	AP DKT4	0687560000
Dimensions see	Page 305		Page 305		Page 305	

Timers

Pulse conditioning DKZ/DKZA timer modules

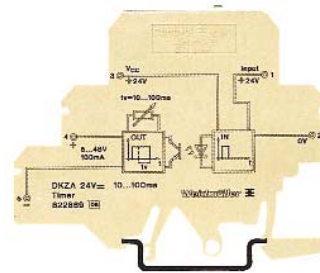
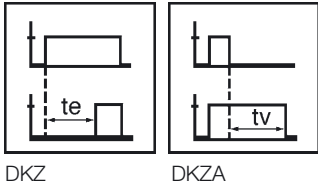

Schematic circuit diagram

DKZ DK5

DKZ DK5

DKZ DK5

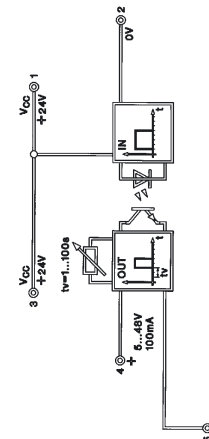
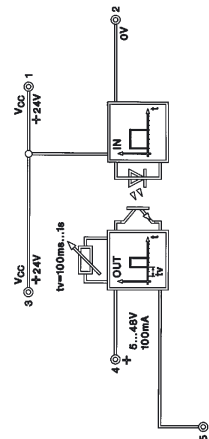
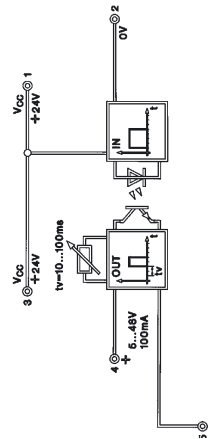

Ordering data

For TS 32
For TS 35
With combi foot TS32/TS 35

Technical data

Input	
Supply voltage	24 Vdc ± 20 %
Supply current	ca. 12 mA
Control voltage	
Control input current	
Output	
Output voltage	5...48 Vdc
Max. output current	100 mA
Internal voltage drop	≤ 1.6 V
Range of switch-on delay	10...100 ms (adjustable)

Type	Cat. No.
DKZ DK5	8228680000

Type	Cat. No.
DKZ DK5	8243780000

Type	Cat. No.
DKZ DK5	8019650000

Isolation coordinates acc. to DIN VDE 0160, Draft11/94

Rated voltage	300 V
Rated impulse voltage	6 kV
Overvoltage category	IV
Pollution severity	2
Clearance and creepage distances	≥ 5.5 mm
Voltage proof, input/output-TS	4 kV _{eff}
Operating temperature	without clearances -25 °C...+40 °C with clearances -25 °C...+50 °C
Storage temperature	-40 °C...+85 °C
Total width	6 mm
Conductor	AWG 22...12
Conductor cross-section	0.5...4 mm ²

Rated voltage	300 V
Rated impulse voltage	6 kV
Overvoltage category	IV
Pollution severity	2
Clearance and creepage distances	≥ 5.5 mm
Voltage proof, input/output-TS	4 kV _{eff}
Operating temperature	-25 °C...+40 °C -25 °C...+50 °C
Storage temperature	-40 °C...+85 °C
Total width	6 mm
Conductor	AWG 22...12
Conductor cross-section	0.5...4 mm ²

Rated voltage	300 V
Rated impulse voltage	6 kV
Overvoltage category	IV
Pollution severity	2
Clearance and creepage distances	≥ 5.5 mm
Voltage proof, input/output-TS	4 kV _{eff}
Operating temperature	-25 °C...+40 °C -25 °C...+50 °C
Storage temperature	-40 °C...+85 °C
Total width	6 mm
Conductor	AWG 22...12
Conductor cross-section	0.5...4 mm ²

Rated voltage	300 V
Rated impulse voltage	6 kV
Overvoltage category	IV
Pollution severity	2
Clearance and creepage distances	≥ 5.5 mm
Voltage proof, input/output-TS	4 kV _{eff}
Operating temperature	-25 °C...+40 °C -25 °C...+50 °C
Storage temperature	-40 °C...+85 °C
Total width	6 mm
Conductor	AWG 22...12
Conductor cross-section	0.5...4 mm ²

Accessories

Type	Cat. No.
End plate	AP DK5 8268870000
Dimensions see	Page 305

Type	Cat. No.
AP DK5	8268870000
Page 305	

Type	Cat. No.
AP DK5	8268870000
Page 305	

Timers

Signal conditioning DKZA timer modules

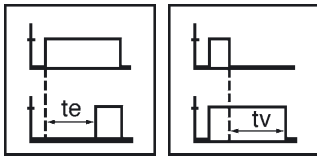

- Components for extending short pulses
- Provides PLC versions with switch-on/off delay
- Fixed times

Schematic circuit diagram

DKZA DK5

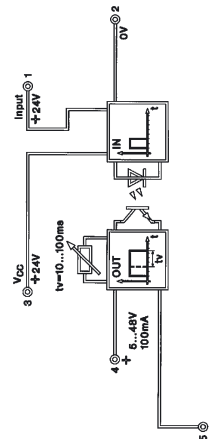

DKA DK5

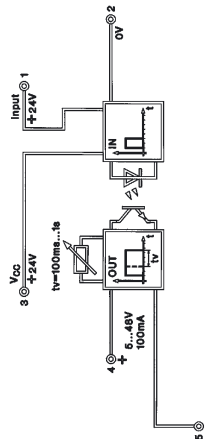

DKZA DK5

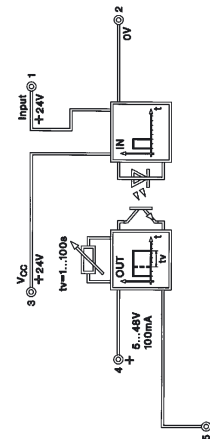

Ordering data

For TS 32

For TS 35

With combi foot TS 32/TS 35

Technical data

Input:

Supply voltage

Supply current

Control voltage

Control input current

Min. pulse duration of input voltage

Output:

Output voltage

Max. output current

Internal voltage drop

Range of switch-off delay

Type Cat. No.

DKZA DK5 **822869000**

Type Cat. No.

DKZA DK5 **824377000**

Type Cat. No.

DKZA DK5 **801963000**

Isolation coordinates acc. to DIN VDE 0160, Draft11/94

Rated voltage

Rated impulse voltage

Oversvoltage category

Pollution severity

Clearance and creepage distances

Voltage proof input/output-TS

Storage temperature

Operating temperature

without clearances

with clearances

Total width

Conductor

Conductor cross-section

300 V

6 kV

IV

2

≥ 5.5 mm

4 kV_{eff}

-25 °C...+40 °C

-25 °C...+50 °C

-40 °C...+85 °C

6 mm

AWG 22...12

0.5...4 mm²

300 V

4 kV_{eff}

IV

2

≥ 5.5 mm

6 kV

-40...+85 °C

-25...+40 °C

-25...+50 °C

6 mm

AWG 22...12

0.5...4 mm²

300 V

4 kV_{eff}

IV

2

≥ 5.5 mm

6 kV

-40...+85 °C

-25...+40 °C

-25...+50 °C

6 mm

AWG 22...12

0.5...4 mm²

Accessories

End plate

Dimensions see

Type Cat. No.

AP DK5 **826887000**

Page 305

Type Cat. No.

AP DK5 **826887000**

Page 305

Type Cat. No.

AP DK5 **826887000**

Page 305

Timers

Turn off delay module MCZ TO

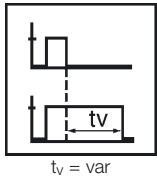

The timer module can be used for extending short pulses and fixed times. Provides PLC versions with switch off delay.

MCZ TO 24 Vdc turn-off delay 50 ms

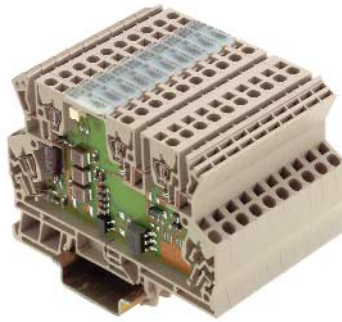

MCZ TO 24 Vdc turn-off delay 150 ms

Schematic circuit diagram

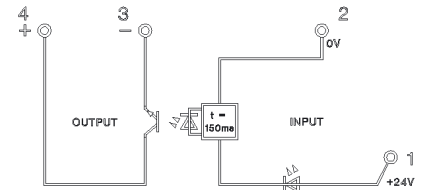
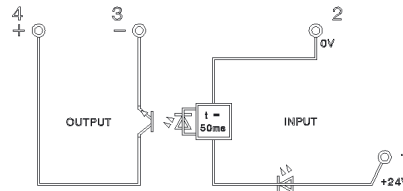

Ordering data

For TS 35

Type
MCZ TO 24 Vdc turn-off delay 50 ms
Cat. No.
832459000

Type
MCZ TO 24 Vdc turn-off delay 150 ms
Cat. No.
828641000

Technical data

Input		Type		Cat. No.	
Input voltage	24 Vdc \pm 10 %	MCZ TO 24 Vdc turn-off delay 50 ms	832459000	MCZ TO 24 Vdc turn-off delay 150 ms	828641000
Min. pulse duration	2 ms				
Power consumption	6.7 mA \pm 10 %				
Input power	160 mW				
Power consumption when pulse applied	200 mA				
Output					
Output voltage	5...48 Vdc				
Max. output current	20 mA				
Max. voltage drop at max. load	\leq 1.6 V				
Impulse loading/limiting overload current	200 mA				
Reverse current at 48 V (static current)	max. 0,16 mA				
Switch-off delay	50 ms				
Switching frequency dc	20 Hz				
Insulation coordination/safe disconnection to EN 50178					
Rated voltage	300 V				
Rated impulse voltage	6 kV				
Overvoltage category	III				
Pollution severity	2				
Clearance and creepage distances	\geq 5.5 mm				
Voltage proof, input/output mounting rail	4 kVeff / 1 min				
Opto coupler	to VDE 0884				
Ambient temperature	-25 °C...+50 °C				
Storage temperature	-40 °C...+85 °C				
Conductor	AWG 22...12				
Conductor cross-section	1.5 mm ²				
Approvals	CE, UL, CSA				
Total width	6 mm				

